

BÜNDNIS 90
THE GREENS

Parliamentary Group

16 44
Jan 2007

Possible European biogas supply strategies

A study on behalf of the Government Parliamentary Group
Bündnis 90/The Greens

W W W.GRUENE-BUNDESTAG.DE

Geschäftsführer / Managing Director:

Prof. Dr.-Ing. Martin Kaltschmitt

Handelsregister: Amtsgericht Leipzig HRB 8071

Sitz und Gerichtsstand Leipzig

Deutsche Kreditbank AG

(BLZ 120 30 000)

Kontonr.: 1364280

Stadt- und Kreissparkasse Leipzig

(BLZ 860 555 92)

Kontonr.: 1100564876



Zert.-Nr. 12100105

Reference: Bündnis 90/The Greens
Government Parliamentary Group
Info-Dienst
Platz der Republik 1
11011 Berlin
Fax: 030/227 56566
Email: versand@gruene-bundestag.de

Protection fee € 2

Final date for publication January 2007

Biogas supply strategy – Government Parliamentary Group Bündnis 90/The Greens – 1/2007

Geschäftsführer / Managing Director:

Prof. Dr.-Ing. Martin Kaltschmitt

Handelsregister: Amtsgericht Leipzig HRB 8071

Sitz und Gerichtsstand Leipzig

Deutsche Kreditbank AG

(BLZ 120 30 000)

Kontonr.: 1364280

Stadt- und Kreissparkasse Leipzig

(BLZ 860 555 92)

Kontonr.: 1100564876



Zert.-Nr. 12100105

Contents:

- **Possible European biogas supply strategies,
Sub-report I, Potentials
produced by Daniela Thrän, Michael Seiffert, Franziska
Müller-Langer, André Plattner, Alexander Vogel**
- **Possibilities within a European biogas supply strategy Sub-report II, ecological
and socio-economic analysis produced by Uwe R. Fritsche,
Katja Hünecke, Klaus Schmidt**
- **Possibilities within a European biogas supply strategy**

Appendix

Geschäftsführer / Managing Director:

Prof. Dr.-Ing. Martin Kaltschmitt

Handelsregister: Amtsgericht Leipzig HRB 8071

Sitz und Gerichtsstand Leipzig

Deutsche Kreditbank AG

(BLZ 120 30 000)

Kontonr.: 1364280

Stadt- und Kreissparkasse Leipzig

(BLZ 860 555 92)

Kontonr.: 1100564876



Zert.-Nr. 12100105

Institut für Energetik und Umwelt
gemeinnützige GmbH

Institute for Energy and Environment



Sub-report I

Possible European biogas supply strategies

Daniela Thrän

Michael Seiffert

Franziska Müller-Langer

André Plättner

Alexander Vogel

January 2007

English translation provided by

nationalgrid

Geschäftsführer / Managing Director:

Prof. Dr.-Ing. Martin Kaltschmitt

Handelsregister: Amtsgericht Leipzig HRB 8071

Sitz und Gerichtsstand Leipzig

Deutsche Kreditbank AG

(BLZ 120 30 000)

Kontonr.: 1364280

Stadt- und Kreissparkasse Leipzig

(BLZ 860 555 92)

Kontonr.: 1100564876



Zert.-Nr. 12100105



Customers: Bundestagsfraktion BÜNDNIS 90/DIE GRÜNEN
Platz der Republik 1
11011 Berlin

Fachverband Biogas
Angerbrunnenstraße 12
85356 Freising

STAWAG
Stadtwerke Aachen AG
Lombardenstraße 12 - 22
52070 Aachen

Contractor: Institut für Energetik und Umwelt gGmbH (IE)
Torgauer Straße 116
04347 Leipzig

☎: +49 (0) 341 / 24 34 – 112

✉: info@ie-leipzig.de

Contact: Dr.-Ing. Daniela Thrän
Institut für Energetik und Umwelt gGmbH
Bereichsleiterin Bioenergiesysteme

☎: +49 (0) 341 – 24 34 – 435

☎: +49 (0) 341 – 24 34 – 133

✉: daniela.thraen@ie-leipzig.de

Leipzig, 25. April 2008



Table of contents

List of illustrations and tables	VIII
List of abbreviations	X
1 Introduction	1
1.1 <i>Background and aims</i>	1
1.2 <i>Object of the study</i>	2
2 Options for generating and supplying biogenous gases	5
2.1 <i>Summary</i>	5
2.2 <i>Description of process for biogas</i>	7
2.2.1 <i>Generation</i>	7
2.2.2 <i>Preparation</i>	8
2.3 <i>Description of Bio-SNG procedure</i>	10
2.3.1 <i>Generation</i>	10
2.3.2 <i>Preparation</i>	10
2.4 <i>Technical status of biomethane generation options</i>	11
2.4.1 <i>Comparing procedures</i>	11
2.4.2 <i>Reference concepts</i>	13
2.5 <i>Supply and transportation</i>	14
2.5.1 <i>Technical classification</i>	14
2.5.2 <i>Classification of the underlying conditions</i>	16
3 Potential	17
3.1 <i>Basic assumptions</i>	17
3.1.1 <i>Basic raw material</i>	17
3.1.2 <i>Availability of acreage for cultivation of fuel crops</i>	18
3.1.3 <i>Fuel crop yields</i>	20
3.1.4 <i>Catchment radii of plants generating and supplying biomethane</i>	21
3.1.5 <i>Use of the gas network</i>	22
3.2 <i>Determining the fuel potential</i>	23
3.2.1 <i>Potential for agriculture</i>	25
3.2.2 <i>Potential for forestry</i>	25
3.2.3 <i>Potential for the wood industry</i>	26
3.3 <i>Determining biomethane potential</i>	26
3.3.1 <i>Current potential</i>	27
3.3.2 <i>Future potential</i>	28
3.4 <i>Classifying the potential</i>	31
3.4.1 <i>Substitution potential</i>	31
3.4.2 <i>Demand for equipment</i>	32
4 Supply costs	34
4.1 <i>Methodical approach</i>	34
4.2 <i>Cost calculation model</i>	34



4.3 <i>Broad assumptions and basis of data</i>	36
4.4 <i>Results</i>	38
5 Current underlying conditions	44
6 Summary and conclusions.....	46
Literature and list of references.....	48

List of illustrations and tables

Illustration 1-1:	Forecast of primary energy consumption for EU-25	1
Illustration 1-2:	Structure plan for the overall study.....	2
Illustration 1-3:	Definitions of concepts	3
Illustration 2-1:	Stages in the process of preparing biogenous gases /2/	5
Illustration 2-2:	The European natural gas network (without showing the pipelines found on the plan, such as Baltic-Nabucco pipeline /3/.....	7
Illustration 2-3:	Layout of an agricultural biogas plant with use of co-substrates /10/	8
Illustration 2-4:	Tried and tested procedure for preparing biogas (PSA Pressure swing adsorption; DWW: Pressurised water wash/35/)	9
Illustration 2-5:	Procedural principle for producing Bio SNA (Biomethane) according to /36/	11
Illustration 2-6:	Reference concept “Biomethane from biogas“ – 1.3 MW _{th} -plant/2/.....	13
Illustration 2-7:	Reference concept “Biomethane from Bio-SNG“ – 167 MW _{th} -plant/2/ ..	14
Illustration 3-1:	Current biomass potential for Germany /2/	17
Illustration 3-2:	Catchment areas for biogas plants	22
Illustration 3-3:	Catchment areas for biogas plants	23
Illustration 3-4:	Current arable land in selected countries of Europe/2/	24
Illustration 3-5:	Current forestry land in selected countries of Europe/2/	24
Illustration 3-6:	Biomethane potential in 2005 according to raw materials.....	27
Illustration 3-7:	Biomethane potential in 2005 according to regions	28
Illustration 3-8:	Biomethane potential in 2020 according to raw materials.....	29
Illustration 3-9:	Biomethane potential in 2020 according to raw materials.....	30
Illustration 3-10:	Biomethane potential in 2020 – “Sensitivity”	31
Illustration 3-11:	Biomethane potential and natural gas consumption for 2005 and 2020 /1/, /35/	32
Illustration 4-1:	Calculation model for determining the specific biomethane supply costs.....	35
Illustration 4-2:	Production and supply costs for biogas and bio- SNG	40
Illustration 4-3:	Production and supply costs for biogas (“sensitivity”).....	41
Illustration 4-4:	Production and supply costs for Bio-SNG (“Sensitivity”)	42
Illustration 4-5:	Comparison of expected biomethane costs (all variants, see. Illustration 2-2 ff.) and current price of natural gas (final customer) in Europe (data from /33/).....	43
Table 2-1:	Properties of biogas and natural gas compared.....	10
Table 2-2:	Technical status and basic raw materials of the various options for generating biomethane/2/.....	12



Table 3-1:	Access to raw materials by biogas and bio- SNG plants along the natural gas pipelines/2/	26
Table 3-2:	Assumptions about the limiting case considerations of future potential	.30
Table 4-1:	Investment costs for equipment for procuring biomethane (natural gas quality)	37
Table4-2:	Important cost parameters. Costs related to consumption and operating /32/ ff.....	38
Table 5-1:	Summary of the current underlying conditions of selected countries of the EU+10 and EU+3+CIS-States	45

**List of abbreviations**

A	Year
BHKW	District heating central plant
CDM	Clean Development Mechanism
CH ₄	Methane
CIS	Commonwealth of Independent States
CO ₂	Carbon dioxide
CO ₂ e	Carbon dioxide equivalent
DT	Steam turbine
EAV	European List of Waste
EE	Renewable energies
EU	European Union
FS	Fresh substrate
FAO	Fruit and Agricultural Organisation (of the United Nations)
FWL	Rated thermal input
GATT	General Agreements on Tariffs and Trade
GJ	Giga joule
GuD	Gas turbine power plant
JI	Joint Implementation
KMU	Small and medium-sized companies (SMEs)
kV	Kilo volt
KW	Power station
kWh	Kilowatt hour
KWK	Combined heat and power system
KUP	Fast growing plantation
Mpa	Mega pascal
MW	Mega watt
Nawaro	Nachwachsende Rohstoffe Renewable raw materials
ORC	Organic-Rankine-Cycle
OSB	Oriented Strand Board
THG	Greenhouse gases
Th	thermal (related to the lower heat value)



US\$	US Dollar
WTO	World Trade Organisation

1 Introduction

1.1 Background and aims

Unlike oil, natural gas is not distributed and sold through a standardised world market but through three regional submarkets (the American, Asian and European markets). This segmentation reflects the considerably higher transport costs involved.

Over the past few decades natural gas has become more important in Europe. With limited own production, most EU states (except for Denmark, Great Britain and the Netherlands) have been forced to turn to imports (Illustration 1-1). The most important suppliers are Russia (West Siberia), Norway and Algeria. At 75%, Germany's dependency on imports is above average.

About one third of the natural gas used in Western Europe and Germany comes from Siberia. The transportation of natural gas across Eastern Europe is through high pressure pipelines within the system set up by the Russian and Eastern European gas industry.

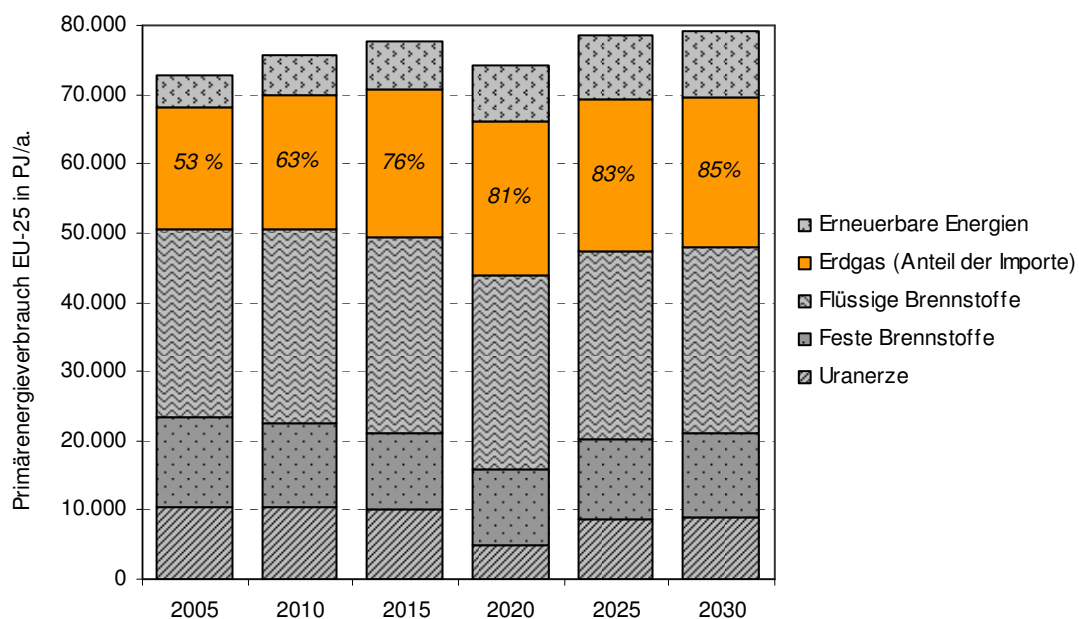

Illustration 1-1: Forecast of primary energy consumption for EU-25

Key:

Primary energy consumption EU-25 in PJ/yr

- Renewable energies
- Natural gas (share of imports)
- Liquid fuels
- Solid fuels
- Uranium ores

At the same time there are signs of considerable biomass potential for both the European Union and the CIS states, with indications that this will rise still more in the future. This should be given a strategic importance in the medium term with respect to the supply of energy. In principle there is an opportunity to prepare biogenous gases along the existing natural gas pipelines, either those being constructed or those still at the planning stage, to prepare these gases to natural gas quality and finally to supply and use them as part of the German and European energy supply. Against this background the aim of this study is to analyse the potential available, the technical aspects, the preparation costs, the legal and underlying conditions in specific markets with respect to the production and injection of biogenous gases into the natural gas pipelines which supply Europe. The significance of this option with respect to the German and European energy supply is then classified.

1.2 Object of the study

To fulfil the aim of the study the opportunities for preparing and supplying biogenous gases to the natural gas pipelines supplying Germany are sketched and an initial estimate of the possible scope of such systems is investigated. The depth of the investigation will not allow us to provide statements on certain subjects, such as the actual possibilities for collaboration in Eastern European states, locations which are very promising. The overall study will be drawn up in collaboration with the Öko-Institut e.V. in Darmstadt. Illustration 1-2 shows the structure plan.

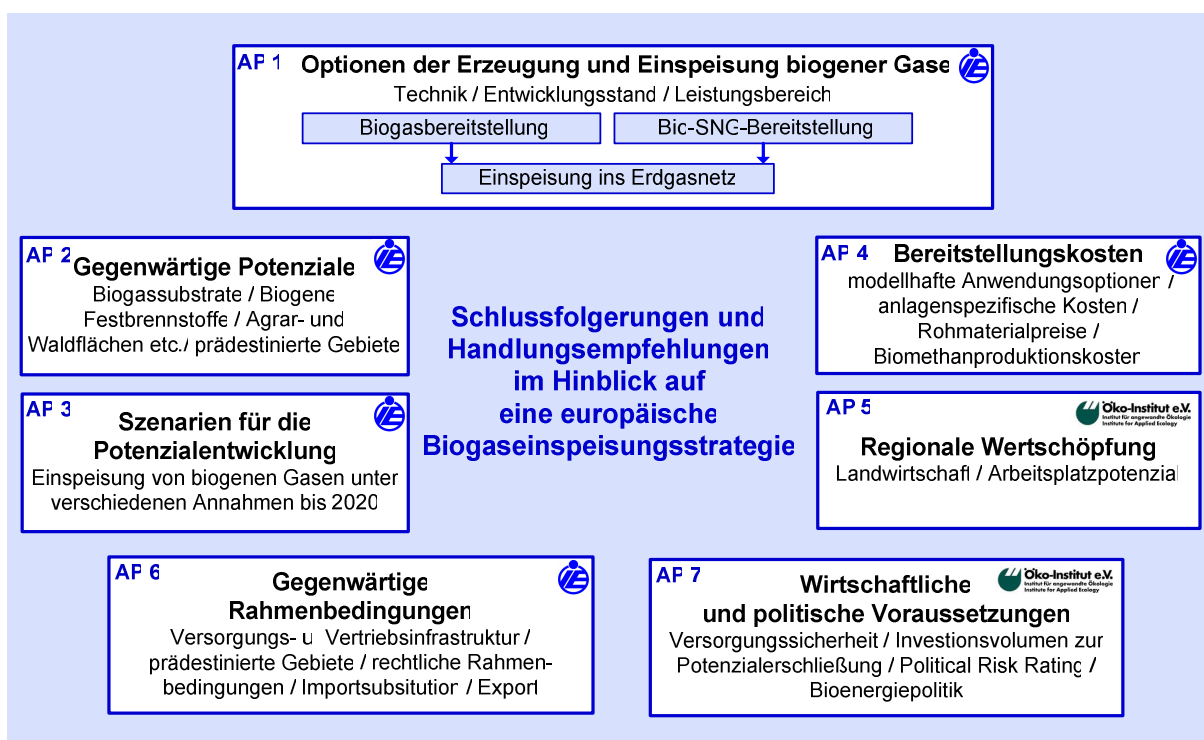

Illustration 1-2: Structure plan for the overall study

Key:

AP 1 Options for generating and supplying biogenous gases Technology/state of development/performance range Biogas preparation Bio-SNG preparation Feeding into the natural gas network		
AP2 Current potential Biogas substrate/biogenous solid fuels/agricultural and forest areas etc/predestined areas	Consequences and recommendations for action with regard to a European biogas supply strategy	AP4 Preparation costs Models of options for use/costs specific to equipment/price of raw materials/biomethane production costs
AP 3 Scenarios for potential development Supplying biogenous gases under various assumptions until 2020		AP5 Regional value creation Farming/job potential
AP 6 Current underlying conditions Supply and marketing structure/predestined areas/ legal underlying conditions/import substitution/export		AP7 Economic and political prerequisites Supply security/investment volume for opening up potential/ political risk rating/bio energy policy

Sub-report I below contains the following core points for estimating whether the use of biogenous gases via trans-national supply networks can be achieved:

- Options for generating and supplying biogenous gases (Chapter 2),
- Usable biomasses and their potential (Chapter 9.3),
- Preparation costs (Chapter 9.4),
- Current underlying conditions (Chapter 5).

The term biogenous gases (biogas or bio SNG) is used to mean gaseous bio-energy carriers which can be generated from various biomasses using different procedures (i.e. based on anaerobic fermentation or more precisely thermochemical gasification). Biogenous gases prepared to natural gas quality are also known as biomethane (Illustration 1-3).

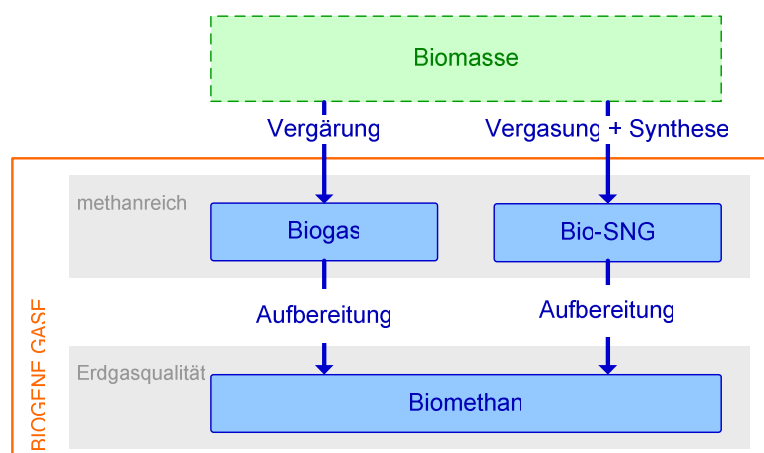

Illustration 1-3: Definitions of concepts

Key:

Biomasse = biomass

Vergärung = fermentation

Vergasung + Synthese = gasification + synthesis

Methanreich = rich in methane

Aufbereitung = preparation

Erdgasqualität = natural gas quality

Biomethan = biomethane



The investigation is limited to Europe (status 01/2006) i.e.:

- “old” member states of the EU (EU-15); here Germany (DE) is shown separately,
- “new” member states of the EU (EU+10 since January 2004),
- states awaiting accession - Bulgaria, Rumania, Turkey (EU+3),
- Soviet succession states - Russia (European part), White Russia and Ukraine (CIS).

An analysis of the current situation is provided (2005) plus an estimate of future trends up to the year 2020. Since the political situation and the situation with data are both different, the details for European Union states are more precise than those for the CIS states – in the latter case the trends assumed for 2020 could clearly be delayed.

2 Options for generating and supplying biogenous gases

2.1 Summary

The generation of biomethane can be done using bio-chemical conversion into biogas (i.e. anaerobic fermentation) or by thermo-chemical conversion into Bio-SNG (i.e. based on biomass fermentation (Illustration 2-1).

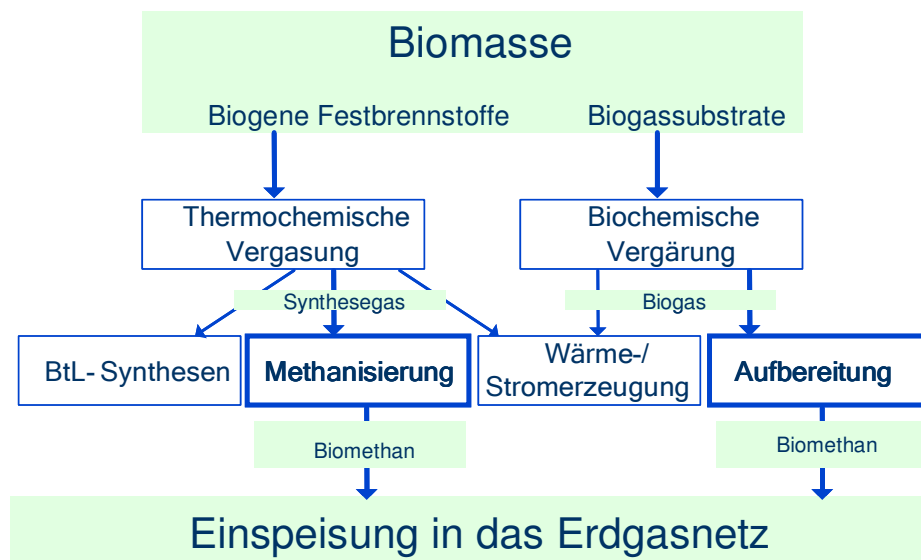

Illustration 2-1: Stages in the process of preparing biogenous gases /2/

Key:

	Biomass		
	Biogenous solid fuels	Biogas substrate	
	Thermochemical gasification	Biochemical fermentation	
	Synthetic gas	Biogas	
BtL syntheses	Methanisation	Heat/power generation	Preparation
	Biomethane		Biomethane
	Feeding into the natural gas network		

The generation technologies for biogas and Bio-SNG are distinct from one another in various respects, including:

- Principle and components of the procedure,
- Technical maturity and need for research,
- Suitable raw materials,
- Output ranges,
- Residual materials and recycling options,
- Expenditure on gas purification for ensuring gas quality.

Before it is possible to feed biogenous gases into the natural gas network there are many procedural stages to work through. The cleaning and/or preparation of gases to natural gas quality have a significant role to play. The increasing of pressure in the gas supplied to reach the pressure prevailing in the natural gas pipeline is also important. Arrangements must be made to transport the biogenous gases to the actual feed point.

When biomethane is fed into the natural gas network it is possible to segregate the place where the gas is used from the place where the gas is produced. Some of the results of this are:

- Supplying areas with high demand for renewable fuels or combustibles (z. B. EU-15),
- Central, and therefore efficient, use of biomasses whose occurrence is decentralised.

Essentially there are transport and distribution networks in almost all European countries which can be used to supply biomethane (Illustration 2-2). With regard to production, access to the networks and basic raw materials are equally vital. With regard to use – as a result of the financial and political underlying conditions, (including Kyoto obligations, specific energy consumption) - there could be heightened demand, above all in the EU-15. A significant demand for transportation from east to west within the biogas supply strategy is becoming evident and needs to be achieved within the high pressure network.

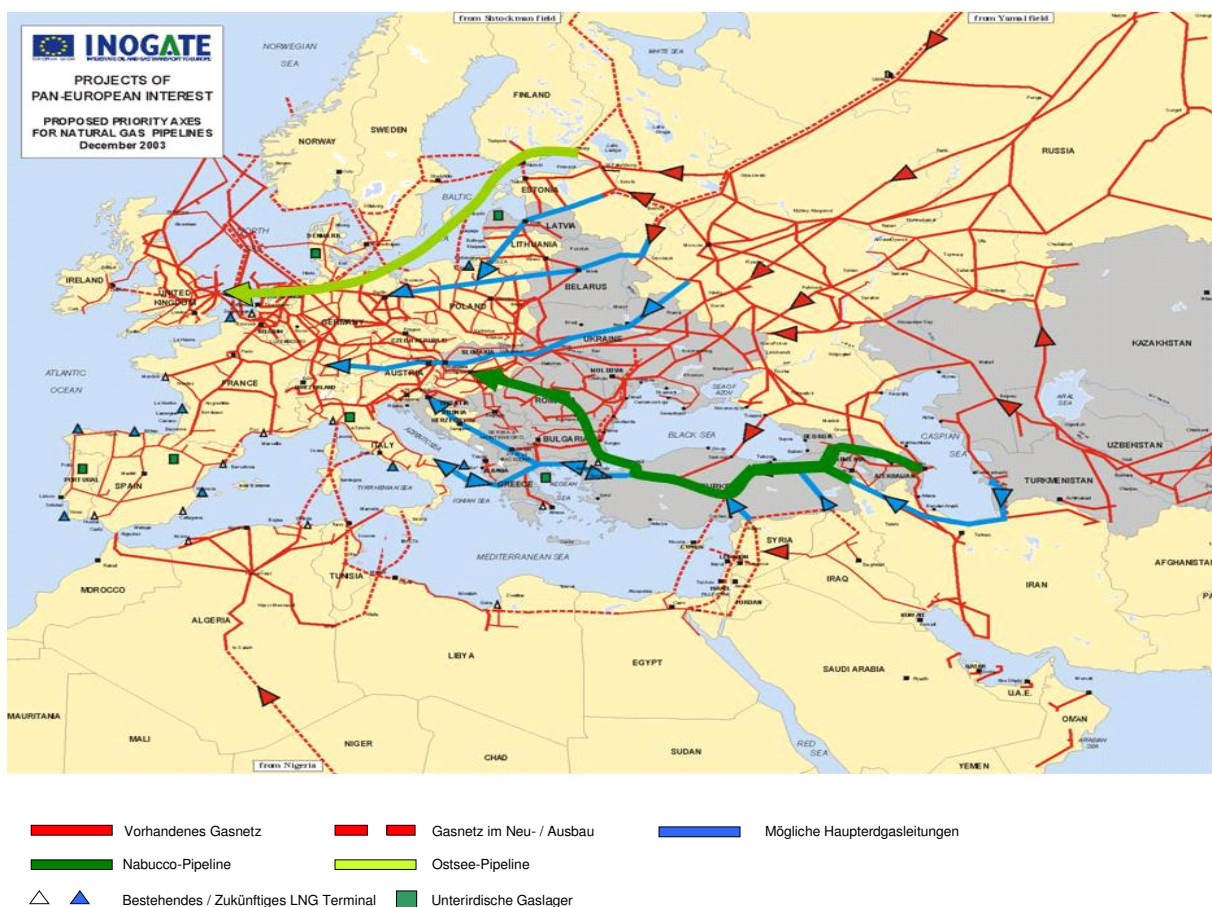

Illustration 2-2: The European natural gas network (without showing the pipelines currently being planned, such as Baltic-Nabucco pipeline) /3/

The facilities for generation and preparation are described separately below for biogas and bio-SNG and then compared using a synoptic comparison. This chapter considers biogas and bio-SNG together, because of the technical processing analogies in the supply and distribution (transport) of biomethane from both bio-chemical and thermo-chemical conversion.

2.2 Description of process for biogas

2.2.1 Generation

Essentially an agricultural biogas plant can be subdivided into four different process stages, irrespective of the method of operation:

- Delivery, warehousing, preparation, transportation and bringing in the substrate
- Extracting biogas
- Storing the fermentation waste and possible preparation and production
- Biogas storage, preparation and use.

Illustration 2-3 shows the plant components, assemblies and equipment systems required in an agricultural biogas plant using co-substrates. The type of technical processing equipment chosen for the plant firstly depends on the substrates available. The quantity of the substrate determines the dimensioning of all equipment and systems and tank volumes. The quality of the substrate (TS content, structure, origin etc) determines the layout of the process technology.

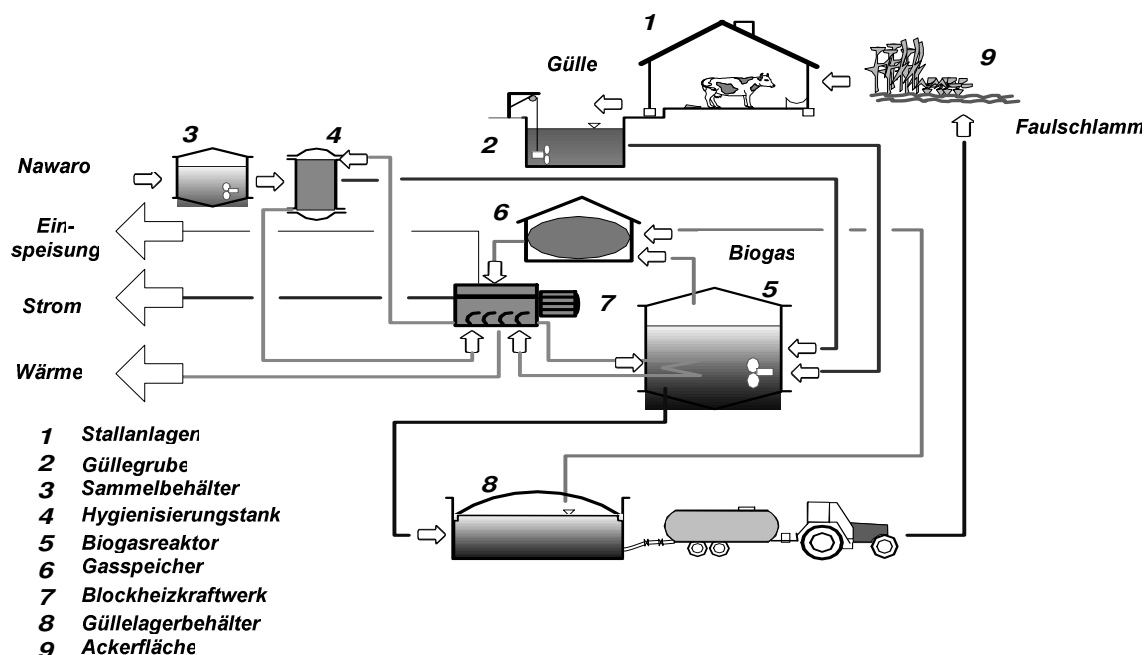



Illustration 2-3: Layout of an agricultural biogas plant with use of co-substrates /10/

Key:

1. Stall facilities
2. Manure pit
3. Collection tank
4. Sanitation tank
5. Biogas reactor
6. Gas storage
7. District heating plant
8. Manure pit tank
9. Arable area

Depending on the composition of the substrate, it may be necessary to separate off any unwanted materials or mash the substrate by adding water so that it can be pumped around. If materials requiring purification are used, a purification stage will need to be planned. The substrate reaches the fermenter after pre-treatment where it is then fermented i.e. the organic substance is converted biochemically, through several stages of decomposition, into biogas. The fermented residue is stored in sealed repeat fermenters for biogas use or in open fermentation residue containers from where it is usually applied to agricultural areas as a liquid fertiliser. The biogas formed during fermentation is stored and then prepared.

2.2.2 Preparation

Biogas is saturated in water and contains methane (CH_4) and carbon dioxide (CO_2) as well as traces of hydrogen sulphide (H_2S). The hydrogen sulphide and the steam contained in the biogas together form sulphuric acid. The acids attack the motors used to recycle the biogas and the components upstream and downstream (gas pipe, flue gas pipe etc). Therefore the biogas acquired is always desulphurised and dried. /10/. Further preparation is also needed before supplying the natural gas networks and this specifically has to include a CO_2 separator. There are various procedures available for this (Illustration 2-4). The procedures shown here, pressure swing adsorption (PSA) and pressurised water washing (DWW), are the technologies mainly being implemented at this time but other procedures, such as chemical washing and diaphragm procedures, are available on the market. The important preparation stages remain the same, however.

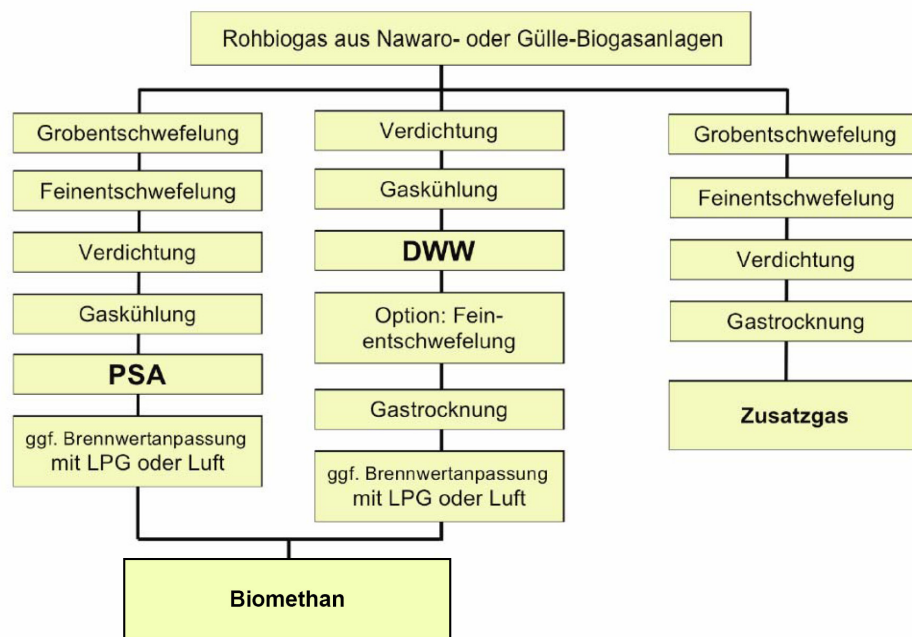

Illustration 2-4: Tried and tested procedure for preparing biogas (PSA Pressure swing adsorption; DWW: Pressurised water wash/35/)

Key:

	Natural biogas from Nawaro or manure biogas plant	
Rough desulphurisation	Compression	Rough desulphurisation
Fine desulphurisation	Gas cooling	Fine desulphurisation
Compression	DWW	Compression
Gas cooling	Option: fine desulphurisation	Gas drying
PSA	Gas drying	Added gas
If applicable adapting the net calorific value with LPG or air	If applicable adapting the net calorific value with LPG or air	
	Biomethane	

Table 2-1: *Properties of biogas and natural gas compared*

Substance	Biogas	Natural gas
Methane	50-70 %	93-98 %
Carbon dioxide	25-40 %	1 %
Nitrogen	< 3 %	1 %
Oxygen	< 2 %	-
Hydrogen	traces	-
Hydrogen sulphide	Up to 4000 ppm	-
Ammonia	Traces	-
Ethane	-	< 3 %
Propane	-	< 2 %
Siloxane	traces	-

2.3 Description of Bio-SNG procedure

2.3.1 Generation

Gasification is the key technology for converting biogenous solid fuels into methane and is gaining more and more significance in this sector/market segment. Gasification means the thermo-chemical conversion of a gasification substance (i.e. fuel) using a gasification agent (e.g. air, oxygen, steam, carbon dioxide) to produce combustible gases (gasification gas or product gas) through partial oxidation (air-fuel ratio < 1). The free or bonded oxygen of the gasification agent is fed into the process under the influence of heat: the solid fuel is then split into gaseous compounds and the remaining carbon is partially burnt becoming carbon monoxide. Depending on the gasification substances, gasification agent and reaction conditions, the gasification gas (product gas) consists of the main components carbon monoxide (CO), hydrogen (H₂), carbon dioxide (CO₂), methane (CH₄), steam (H₂O) and – when gasification is with air – considerable amounts of nitrogen (N₂).

In principle, various gasification processes can be used to methanise the product gas. The use of fluidised bed gasification seems reasonable based on the minimum output required and the requirements regarding product gas quality. Of the processes available, the procedure using the Güssing concept (allothermic dual bed fluidisation) is particularly well developed technically (high availability and reliability, operating experience of several 10,000 hrs). Also it offers further technical advantages (above all good gas properties for SNG production, possibility of integrating caloric gas cleaning residues.)

2.3.2 Preparation

Various procedural stages are required to clean the product gas and firstly dusts and tars are separated off once the gas is cooled. After compression, the product gas can immediately be used for generating energy and heat while higher gas purity is required to synthesise biogenous gases. Before it can comply with the quality requirements, the pre-cleaned product gas must be compressed several times, washed and dried and then go through additional cleaning stages (e.g. fine cleaning, washing out sulphur and chlorine components) /9/. During

further stages of the process, bio-SNG (biomethane) is generated from the product gases using stage by stage methanisation. Illustration 205 shows the important process stages for SNG production.

Irrespective of the synthesis process and the technologies used, it is vital that the gas is appropriately cooled: the heat occurring can, for example, be connected to a low temperature closed process (ORC) for producing energy, or low calorie heat can be used to generate remote/district heat – depending on the concept..

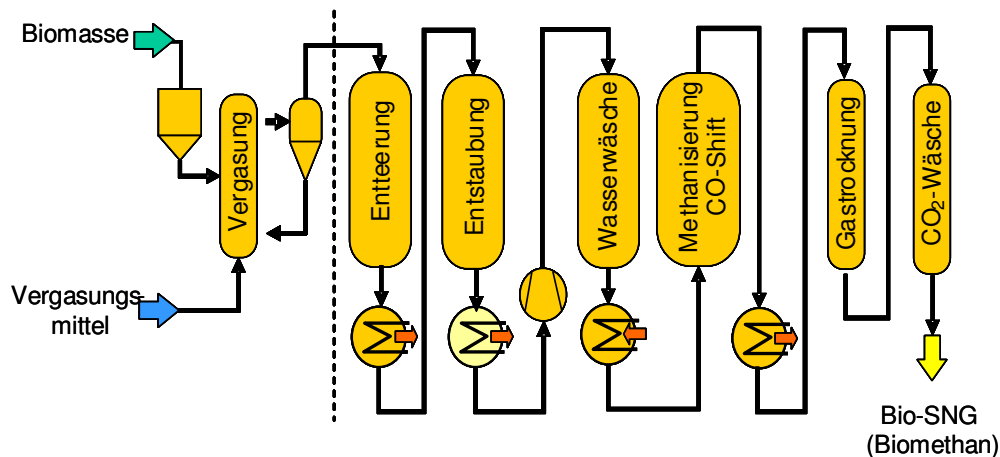

Illustration 2-5: Procedural principle for producing Bio SNA (Biomethane) according to /36/

Key:

Biomass
 Gasification, emptying, dedusting, water wash, methanisation CO shift, gas drying, CO₂ wash
 Gasification agent
 Bio SNG (Biomethane)

2.4 Technical status of biomethane generation options

2.4.1 Comparing procedures

The state of the art for the generation of biomethane using biogas or bio-SNG is compared in Table 2-2. Clearly there are differences in technical maturity, basic raw materials and output range:

- As far as the technical maturity is concerned, bio-SNG plants can be expected from about 2015 onwards, whereas biogas plants have already been built for generating electricity in various forms.
- Because of the different basic raw materials required we need not expect competition for raw materials between the technological options; but in some instances there may be competition over arable areas for cultivating fuel crops (areas are only available once).

- The decisive factor with regard to the plant output range is the capacity for transporting the biomass used. Essentially bio SNG plants are based on more easily transportable substrates with the result that – in connection with supplying gas – it should be possible to develop a larger resource base (“catchment corridors along gas pipelines.”)

The gas yields per area to be expected when using fuel crops are similar. Both procedures demonstrate similar raw material efficiency: the decisive factors are the local conditions (i.e. soil, climate etc.)

Table 2-2: *State of the art and basic raw materials of the various options for generating biomethane/2/*

	Biogas	Bio-SNG
Technical maturity	<ul style="list-style-type: none"> ⇒ Biogas acquisition available on market (about 3000 plants in Germany) ⇒ Components for preparing biogas at natural gas quality exist, particularly in the European countries outside of Germany, for permanent use over many years 	<ul style="list-style-type: none"> ⇒ Gasification process for fossil input materials state of the art ⇒ Demo plant from about 2008 ⇒ If applicable availability from 2015
Need for research	<ul style="list-style-type: none"> ⇒ Optimising control and regulation of the biogas process and the preparation of fermentation residue ⇒ Upscaling biogas plants ⇒ Optimising biogas cleaning ⇒ Developing a concept for preparation and feeding into the natural gas network ⇒ Optimising costs and implementation 	<ul style="list-style-type: none"> ⇒ Ongoing development and upscaling of biomass gasification ⇒ Gas cleaning/conditioning for suitable substitute natural gas ⇒ Upscaling methanisation (synthesis) and testing the catalysts' working life ⇒ Efficient interplay of system components ⇒ Demonstration of availability and reliability ⇒ Cost reduction and implementation
Output classes	Small output range of about 1 to 8 MW _{CH₄,th} (equivalent to about 0.77 to 6.2 mil. m ³ _N)	Large output range of about 85 to 340 MW _{CH₄,th} (equivalent to about 65 to 260 mil. m ³ _N)
Suitable raw materials	Biogas substrate (predominantly liquid or pasty, but also solid), particularly manure, organic residues and silage (e.g. maize, grain, grass)	Biogenous solid fuels above all woody raw material (e.g. forestry waste wood, industrial residue wood, fast growing wood)
Unwanted components	Lignocellulose (does not decompose), heavy metals, toxic substances	Nutrients and substances forming ash (crop stalk type raw materials such as straw, miscanthus etc therefore technically more difficult)
Raw material requirement	About 15,000 tons fresh mass per year per MW _{CH₄,th}	About 3500 t fresh mass per year per MW _{CH₄,th}
Transportability of the raw materials	limited (5 to 30 km)	Essentially a given (single mode up to 150 km); adapted logistics concepts required
Methane yield for a specific surface (fuel crops)	3000 to 4500 m ³ _N /(ha a) (e.g. maize silage)	33,500 to 5,000 m ³ _N /(ha a) (fast growing wood, e.g. willow)

2.4.2 Basic concepts

Two reference concepts have been devised for preparing biomethane from biogas or bio-SNG and these require more extensive consideration. They are shown in Illustration 2-6 (reference concept “Biomethane from Biogas”) and Illustration 2-7 (Reference concept “Biomethane from bio-SNG). The flows of substances described, the uses of energy etc form the basis for the calculations of efficiency in Chapter 4.

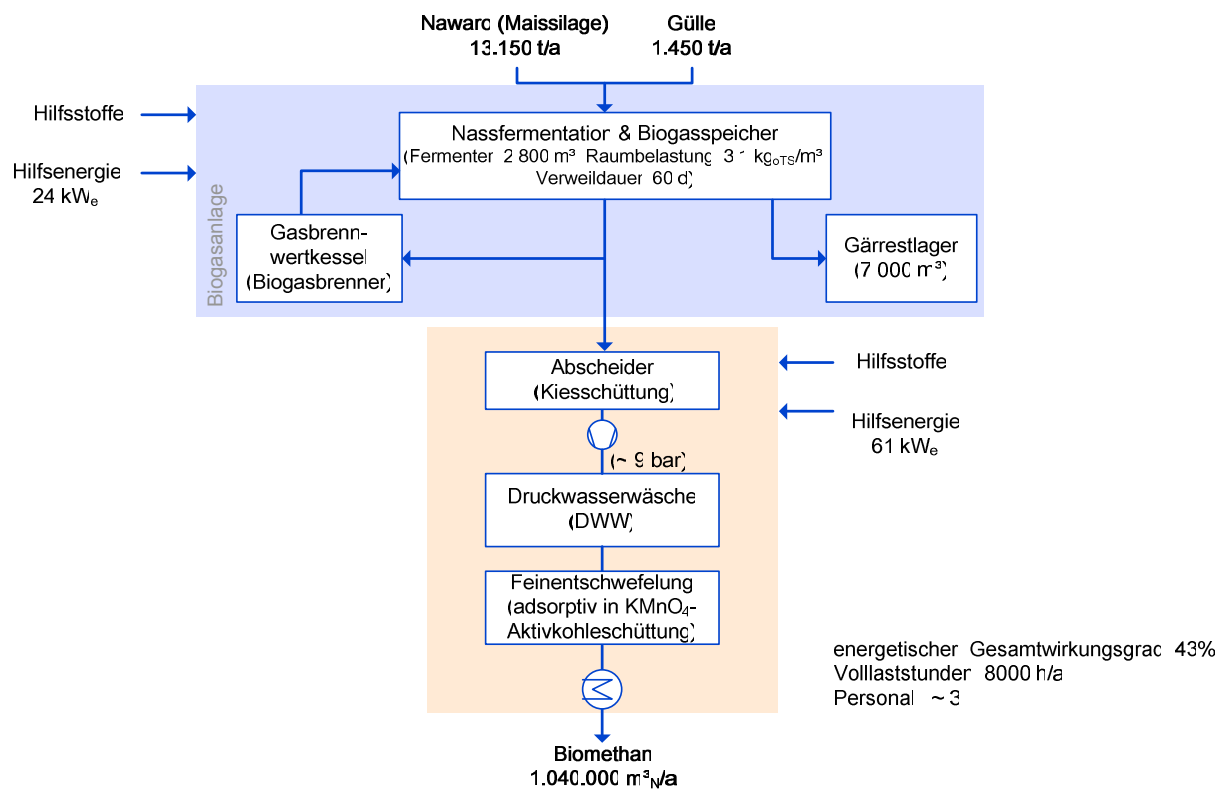
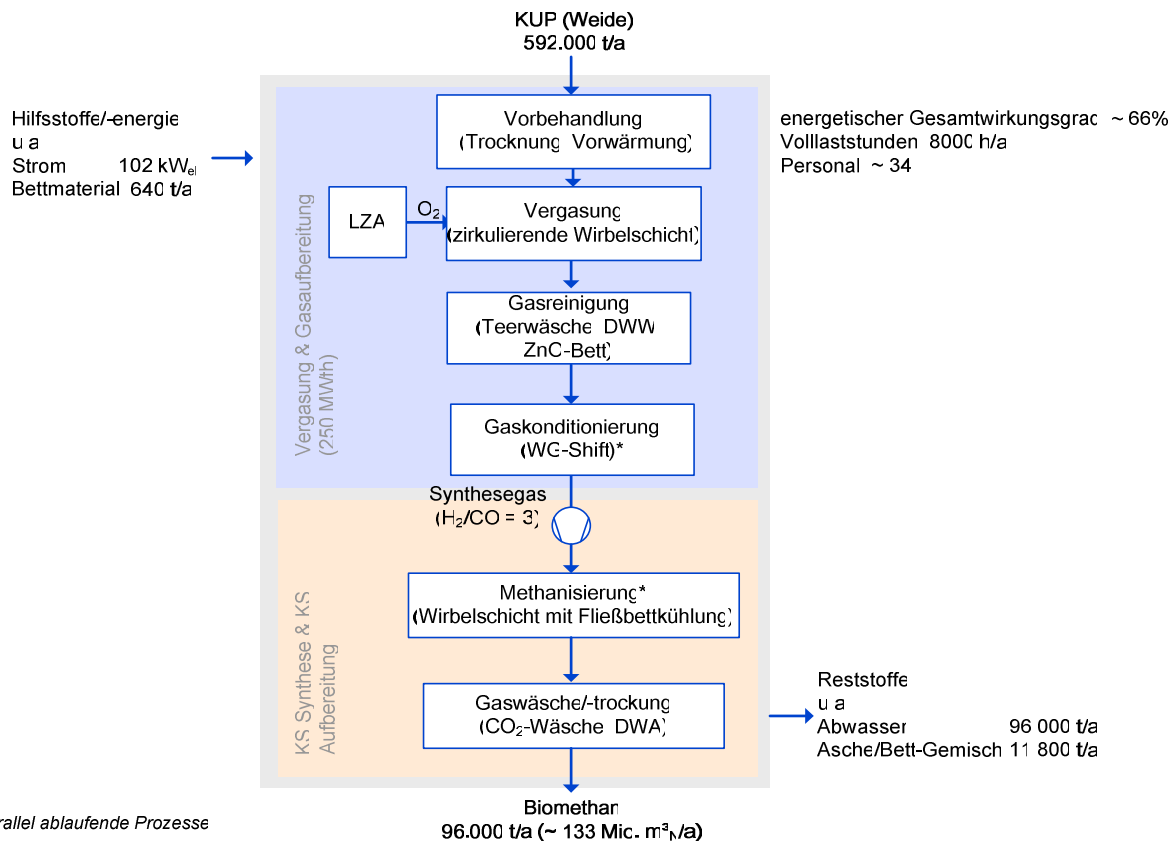

Illustration 2-6: Reference concept “Biomethane from biogas“ – 1.3 MW_{th}-plant/2/

Key:

	Nawarc (maize silage) 13,150 t/a	Manure 1450 t/a	
Auxiliary substances Auxiliary energy 24 kW _{el}	Wet fermentation & biogas store (fermenter: 2800 m ³ , room load: 3.1 kg _{O₂S} /m ³ , Time spent: 60 d)		
	Gas condensing boiler (biogas burner)		Manure residue store (7,000 m ³)
		Separator (gravel heap)	Secondary material
		Pressurised water wash (DWW)	
		Fine desulphurisation (adsorptive in active coal heap)	Energetic total efficiency: 43% Full load hours: 8000 hr/a Personnel: ~3
		Biomethane	

Illustration 2-7: Reference concept "Biomethane from Bio-SNG" – 167 MW_{th}-plant/2/

Key:

	KUP (willow) 592,000 t/a	
Secondary substances/energy including Electricity 102 kW _{el} Bed material 640 t/a	Pre-treatment (drying, preheating)	Energetic total efficiency: 66% Full load hours: 8000 hr/a Personnel: ~34
	Gasification (circulating fluidised bed)	
	Gas purification (tar wash, DWW, ZnO bed)	
	Gas conditioning (WG shift)*	
	Substitute gas	
	Methanisation* (fluidised bed with fluidised bed cooling)	
	Gas washing/drying (CO ₂ wash, DWA)	Residues including Waste water 96,000 t/a Ash, bed mixture 11,800 t/a
* processes running in parallel	Biomethane 96,000 t/a (~133 mil m ³ /annum)	

2.5 Supply and transportation

2.5.1 Technical classification

The natural gas network is subdivided into four supply network levels. The international long distance network (level 1) is operated at a nominal pressure of between 80 and 120 bar. The volume flow under standard conditions is about 1.0 to 2.5 million m³_N/h. The pressure in the pipeline depends firstly on the mains hydraulic conditions (temperature, height, pipe friction)



or the particular point in the gas mains under consideration. On the other hand the pressure is changed in order to compensate for differences in the network load. In summer months, for example, the output pressure is higher in that the gas supplied but not consumed can be stored in the network in the interim. This can lead to an increase in pressure, depending on the design, e.g. from 80 bar to 90 bar, and would mean an additional pressure adjustment in summer when supplying biogas.

To compensate for the various hydraulic conditions, the distance between the compressor stations in the long distance transportation network is between 100 and 200 km /4/. The permitted pressure drop between compressors may vary between 1.2 and 1.4 /4/; for example this means that at 80 bar nominal pressure a pressure of from 67 to 57 bars is set before the next compressor station. This is a preferred position for injecting gas because this will mean lower costs involved in adjusting pressure.

The **internal German (national) long distance transport network** (level 2) connects the international transport level to regional or local supply areas. These pipes are operated at a nominal pressure of between 25 to 80 bar. The **regional networks** (level 3) connect the long distance transport pipelines to the local distribution level. Regional pipelines are operated over a broad range from 1 to 70 bar. **Local distribution networks** (level 4) are narrowly meshed networks which are used for the local supply of natural gas. At the lowest network level the nominal values of flow pressure are between ≤ 30 and 100 mbar.

The study “Feeding biogas into the natural gas network” investigated the injection of prepared biogas into levels 2 to 4 /5/. In the study a reference was made to the various restrictions to be observed. As a result we found that there are no restrictions regarding feeding the relatively low volume flows from biogas generation into the high pressure network. Medium and low pressure networks cannot offer sufficient buffers for intermediate storage of gas in largish quantities. The gas physically fed into the pipeline must also be physically removed from the pipeline in due course. Feeding gas into these pressure stages would require special investigation in each particular case.

Technically the supply of prepared biogas of quality equivalent to natural gas into a high pressure long distance pipeline is achievable. Appropriate compressors with various designs for lower volume flows are available on the market.

When supplying gas into a pipeline it is necessary to increase the pressure so that it is above that found in the transporting pipeline at the point of injection before the gas is distributed into the network downstream. Therefore measurement and regulation of pressure level is required at each feed point.

The compression of natural gas to a high pressure level occurs over many stages and depends on the compression ratio of the compressors chosen. During compression the fluid becomes heated and may need to be cooled. The energetic consumption during compression is between 2 and 10% of the transported energy of natural gases depending on technical efficiency



(compressor and drive system), compression ratio of the compressor, composition of the gas (e.g. natural gas L or H) and starting temperature. Reciprocating compressors may be used for compressing low volume flows. Turbo compressors are usually used to compress high volume flows of natural gas during long distance transportation where a component current of natural gas is used to drive the compressor/4/.

Although technically feasible and although the technologies exist, the increasing of pressure and feeding of prepared biogas or SNG into the long distance transport network is not state of the art. It is not easy to estimate the actual costs which will be incurred. The nature of the gas in the biogas or SNG prepared has a considerable role to play in the design of the compressors and accessories required.

It must always be preferable to feed gas into an existing supply network at low pressure level and then use it in the same network at a low pressure. The calculation of the gas volumes fed in and taken out at another remote place as an energy equivalent (balance group), has to be considered in the context of the appropriate underlying policy conditions.

2.5.2 Classification of the underlying conditions

Currently the liberalisation of the gas market is occurring in the context of the Energy Finance Law (EnWG). This has regularly caused discussions centred on a multiplicity of problems (e.g. physical gas transportation, network hydraulics, contractual models, balance groups, calculation, monitoring net calorific value) for which there are currently no conclusive solutions in Germany.

The transportation costs in the supply district belonging to a network operator are shared among the gas release points using complicated mathematical distribution calculations. This means that there is no conclusive evidence, at this point, regarding the costs incurred. In each individual case a model calculation at a removal point in one zone and at a removal point nearby in another zone may throw up significant cost deviations. The costs incurred in the long distance transportation of biomethane cannot be determined with any certainty because the transportation of natural gas and gas supply volumes regulated in international supplier contracts are for considerably higher transported volumes.

The current situation in the Eastern European gas market – particularly Russia – does not encourage us to expect any comparable liberalisation in the future either. A physical feed point is, at the same time, also a potential release point and this has a major role to play politically (e.g. with reference to the Ukraine conflict). We can therefore assume that the supplying of third party gases (biogas or SNG) to the existing gas transportation network will not occur automatically. We also have to look at requirements for ensuring gas quality and the expected supply costs.

3 Potential

Below is a list of potential ideas for generating and injecting biogenous gases in Europe. These are:

- estimating **the technical fuel potential (primary energy source potential)** i.e. the fuel quantities which can be provided for generating biogas and bio-SNG, from a technical view point,
- deriving the **technical biomethane potential (secondary energy source potential)** taking account of typical catchment radii for feeding into the natural gas network.

By definition, the technical potential makes allowance for flows of materials for food production and the use of materials externally but not for alternative uses (including those already established) for energy generation purposes /10/.

3.1 Basic assumptions

3.1.1 Basic raw material

Many kinds of biomasses can be used to generate biogenous gases. A summary of the current biomass potential of Germany is shown in Illustration 3-1. The proportions of individual biomass groups are also shown for Europe.

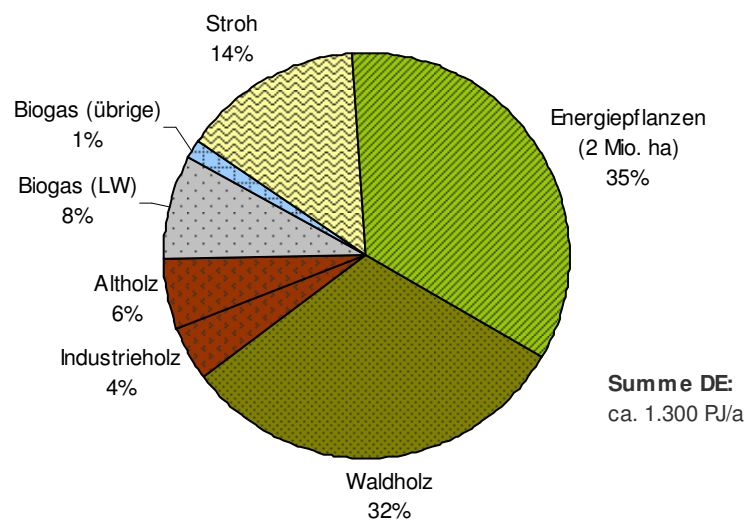

Illustration 3-1: Current biomass potential for Germany /2/

Key:
 Stroh = straw
 Biogas (others) 1%
 Fuel crops (2 mil ha 35%
 Recycled wood 6%
 Industrial wood 4%
 Total DE: about 1300 PJ/annum
 Forestry wood
 32%



With regard to the European biogas strategy (generation of biomethane of defined quality in large plants) the groupings are as follows:

- **Fuel crops, forestry (waste) wood, industrial residue wood and agricultural residues (manure)** are suitable, in terms of quality and raw material logistics, for use in plants for generating and supplying biogenous gases.
- **Waste groups** occur on an ad hoc basis, are greatly encumbered by impurities and are sometimes difficult to estimate with regard to future volume flows- accordingly they have not been considered below.
- **Straw and material from landscape preservation** have beneficial properties and contents for biogas and bio-SNG production but they also bring the risk of affecting nutrient cycles adversely (if they are taken without moderation). This meant that straw was not included when considering potential.

The entire potential from agriculture and forestry as potential basic raw materials has been taken into account but only about 50% from the residues, by-products and waste sector have been included; this means a reduction in the European Union of about 10 to 15% of overall potential compared to the unlimited use of biomass potential for generating biomethane¹: the effect would probably be lower in the CIS states.

The potential which was not taken into account may be used in an isolated case for preparing biogenous gases but is not entirely suitable as a strategic element within a European strategy for supplying biogenous gases.

3.1.2 Availability of acreage for cultivation of fuel crops

Fuel crops can be cultivated on areas which are not required for producing food; this also supports food self-sufficiency in the regions.

EU agricultural policy has mainly developed under the influence of GATT and WTO negotiations where the reduction of domestic agricultural price supports, the reduction of export subsidies and the opening up of markets to third party countries are all central features. This development indicates that many acres will be released, having been predominantly generated by the processes below:

- by technical progress in the agricultural production of raw materials (increase in income) and animal production (more efficient use of feed)
- through the reduction in subsidised exports,
- by deregulation of payments,
- by the expansion in the east.

¹ The flows of materials not considered in DE (2010): 220 PJ/a from about 1500 PJ/a or in EU-28 (2010): 1300 PJ/a from about 11000 PJ/a (data from /10/).



In future several resources will be available in the EU for cultivating bio energy carriers including areas lying fallow, former sugar beet cultivation acreage (reform of sugar market regulation) and roughage land (land which is released because less livestock are being kept). Also we should mention the rise in yields expected in Eastern Europe which will provide further potential for biomass production. You will find detailed estimates in /10/. The potential acreage found there (i.e. in 10) was used as a basis for calculating the generation potential for biogenous gases.

There is no comparable data available for the CIS states. It is not possible to determine any reliable potential acreage using trend updates (see /10/), (retrograde trend with insufficient self-sufficiency with foodstuffs.)

As a result the estimate was based on an agricultural policy classification of the three countries:

- **The agricultural policy of Russia** is based on three reform programmes² which include many aims and measures in agricultural policy programmes. Programmes for formulating the institutional underlying conditions are aimed at creating “more efficient“ agricultural markets, securing risk, improving the competition for agricultural products, improving the professional qualifications of work forces and developing a functioning land market. Programmes to support financial processes and financial structures are clearly controlling and protectionist in nature. Here the “control” refers to the promotion of certain branches of production (self-sufficiency for meat, eggs, milk and milk products and fruit and vegetables) and the restructuring of agricultural businesses. The protectionist alignment is clear from the increasing regulation in internal and external policy which is playing a significant role in future Russian agricultural policy /24/. Biomass production has no significance within the current agricultural policy.
- **White Russia’s agricultural policy** is aimed at stable production growth for agricultural companies³ and the best possible full use of potential (e.g. to do with soil climate, technical material) and resources (e.g. technically, organisationally). This is to secure a stable food supply for the local population. The protection of domestic agricultural production and the subsidising of exports are highly significant. Because of the high degree of government involvement and the policy of sustaining planned economic structures (business and organisational structures of agricultural companies in form of “Sowchosen” and “Kolchosen”) it seems unlikely that they will turn to non-food cultivation (e.g. bio energy crop cultivation) (except for cultivation of animal fodder)/20/.

² The three reform programmes can be divided into the longer term (“basic alignment of agricultural and food policy for the years 2001 to 2010“) the medium term (“programme of socio-economic development of the Russian Federation from a medium term perspective (2003 to 2005“) and the short term reform programme.

³ The development of agricultural structures is mainly based on the promotion of big business structures as there is no alternative to large scale production in the agricultural sector /20/



- Like Russia and White Russia **the Ukraine** shows a lack of clear ideas for reforming the agricultural sector. Like the Russian and White Russian agricultural economies, the Ukraine is suffering from the continuous regression of agricultural production. To combat this phenomenon, Ukrainian agricultural policy currently recommends measures such as intervention systems and quota rules which promote the protection of agriculture. The situation in the dysfunctional land market also appears problematical. The mobility problems for land which this causes, (non-existent resource allocation), have a particularly serious effect on agricultural companies and the availability of capital. This is not only damaging for the Ukrainian economy but is also wasting existing potential⁴. Despite far-reaching problems in the areas of food and animal feed production, demands for the extension of fuel crop cultivation are increasingly coming to light (e.g. extension of cultivation of rape from the current 1% of arable land to 10% by 2010).

It is correct to say that the countries, Russia, White Russia and Ukraine possess significant physical potential for biomass preparation in agriculture, but their use is severely limited because policy aims frequently oppose this and also because there is competition with food and fodder crop cultivation (frequently degree of self sufficiency below 100%). As to future fuel crop potential, we can assume that if the market is sufficiently attractive the performance of agriculture may be increased in the medium term. There are the first signs of this, including rape production in the Ukraine /26/. Based on these considerations the potential acreage for cultivation of fuel crops in the CIS states is estimated at 10% in 2005 and 20% in 2020.

Although, in principle, the release of acreage as a result of improved agricultural production conditions is almost certain, the question of whether this will be attained by 2020 to the extent expected is uncertain: agricultural experts feel that the possibility of land being released in the medium term is much lower /11/ whereas biomass researchers are expecting release figures which are often considerably higher /12/.

The future release of land has a dominating influence in terms of potential. Therefore sensitivity analyses are being carried out. The supply of food is retained in full in all hypotheses.

3.1.3 Fuel crop yields

Various fuel crops can be cultivated on the land released. A variety of biogas substrates will be grown for the generation of biogas but it will be predominantly wood which is grown for the generation of bio-SNG (so-called fast growing wood such as willow.)

In principle there can be large yield deviations when cultivating biogas substrates and fast-growing wood for SNG production. Throughout Europe fresh mass yields of 15 to 60 t (ha a) (maize) or 2 to 8 t (ha a) (grain) have been recorded, with fresh mass yields of 10 to 35 t/(ha a) for wood /13/. Although literature suggests increases in yields for both systems /13/14/

⁴ While fertile land in the Ukraine is not combined with the best management and know how: in other places the production of agricultural products occurs under economically marginal and ecologically dubious conditions /25/



many kinds of site conditions were noted which cannot be taken into consideration with regard to the questions asked here.

Standardised and moderate fuel crop biomethane yields are assumed in the model calculations, for all regions and points in time:

- Regional standardisation assumes that the required fuel crop volumes and qualities can only be prepared in large, technically optimised production systems which should be of a similar technical standard throughout Europe (and therefore have a comparable yield level).
- Time standardisation assumes that a European strategy for biomethane cannot be implemented in the short term and therefore the expected increase in yield can be expected when there is established cultivation of fuel crops, but that this will be post 2020.
- The moderate yield expectations were used to take account of the many kinds of site conditions which are not provided in more detail here.
- The equal treatment of biogas and bio-SNG is based on similar methane yields per acre from both systems (the generation of biomethane of $35 \text{ t}_{\text{FM}}/(\text{ha} \cdot \text{a})$ from maize is approximately equivalent to the $20 \text{ t}_{\text{FM}}/(\text{ha} \cdot \text{a})$ from fast growing wood).

For all raw materials (biogas and bio-SNG) a methane yield of $3,750 \text{ m}^3_{\text{N}}/(\text{ha} \cdot \text{a})$ is assumed (corresponds to a fresh mass yield of $35 \text{ t}_{\text{FM}}/(\text{ha} \cdot \text{a})$ for biogas substrate and/or $20 \text{ t}_{\text{FM}}/(\text{ha} \cdot \text{a})$ for fast growing wood). A supplementary sensitivity analysis will consider the effect of an increase in yield of 30% by the year 2020.

3.1.4 Catchment radii of plants generating and supplying biomethane

Conversion plants (biogas, gasification plants) are located in the direct vicinity of the existing gas network. The substrates needed for operating the plant are obtained over a defined catchments radius (biogas substrate $\leq 30 \text{ km}$; bio-SNG substrate $\leq 150 \text{ km}$); within these corridors there is then a partial area available for the cultivation of fuel crops (e.g.. 10 % of arable land in the corridors of the CIS states for estimating current potential); i.e. food for the calculated self-sufficiency continues to be produced unrestrictedly here as well.

Accordingly not all substrates for use in energy provision can be used in all countries. Illustrations 3-2 and 3-3 below show the current corridors which would arise for biogas or bio-SNG supply. It is possible to see that the corridor for biogas generation compared to bio-SNG is clearly smaller because the biogas substrate⁵ cannot be transported over large distances.

⁵ In principle the biogas corridors can be extended by the construction of local and regional networks. From a supply point of view such an approach may be sensible. For the approach chosen, however, the total potential does not change; only the proportion of biogas would then appear larger.

3.1.5 Use of the gas network

The current gas network is used as a basis for calculations. Only the transportation network is taken into account for Eastern Europe whereas the distribution network is also included for Western Europe. We expect that local and regional gas supply systems may become significant as part of a European strategy for biomethane. In principle a similar use structure is also possible for Eastern Europe but, in view of underlying policy conditions, the establishment of such structures by 2020 seems improbable.

The extension plans for the gas network are not being considered further because they will only have minor effects on the supply scenarios for biomethane and can be politically uncertain.



Illustration 3-2: Catchment areas for biogas plants

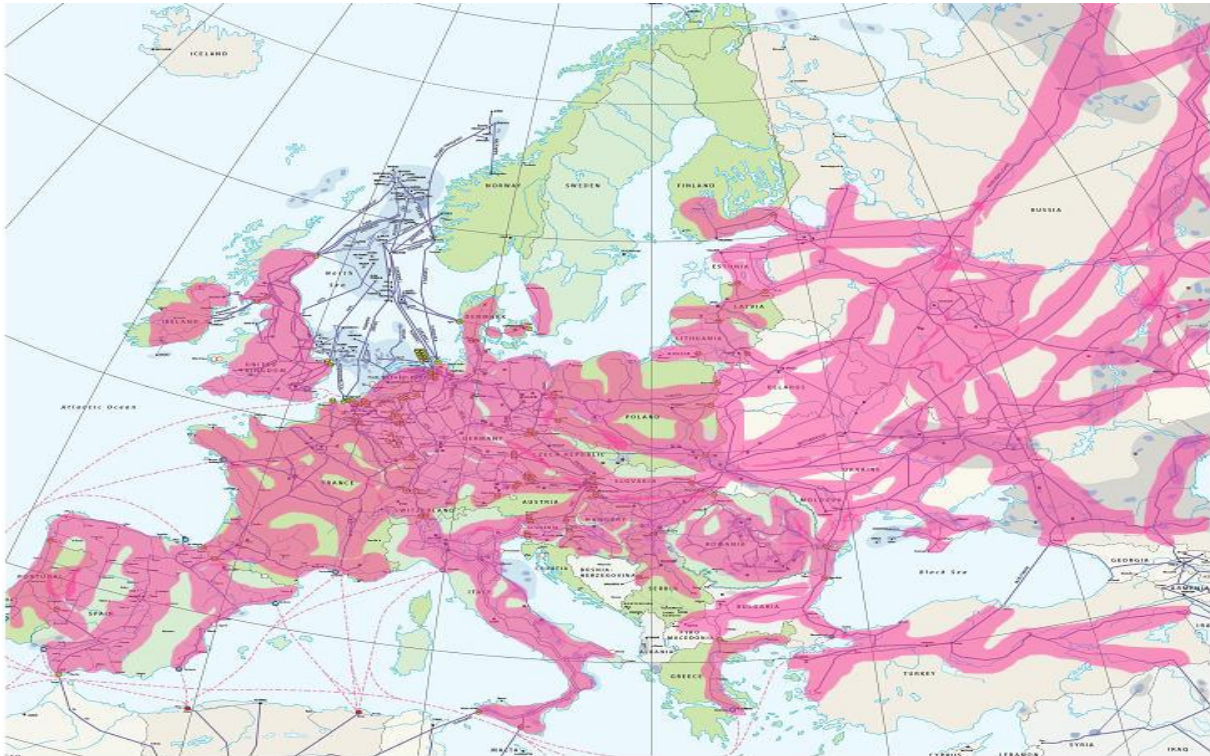

Illustration 3-3: Catchment areas for bio-SNG plants

3.2 Determining the fuel potential

Three areas of origin are used to determine technical biomass potential /10/:

- agriculture and farming,
- forestry and
- the wood industry.

The potential from forestry and the wood processing industry is only significant for bio-SNG production. The important assumptions made when calculating potential are shown below. Detailed calculations of potential can be found in Annex A. The specific arable and forestry land proportions in Illustration 3-4 f are a prime characteristic of the countries under consideration. Countries like the Ukraine, Hungary, Denmark and also France, Poland and Germany have significant arable potential which is available for cultivating fuel crops. As expected, countries like Russia, Sweden and Finland have the highest proportions of forests.

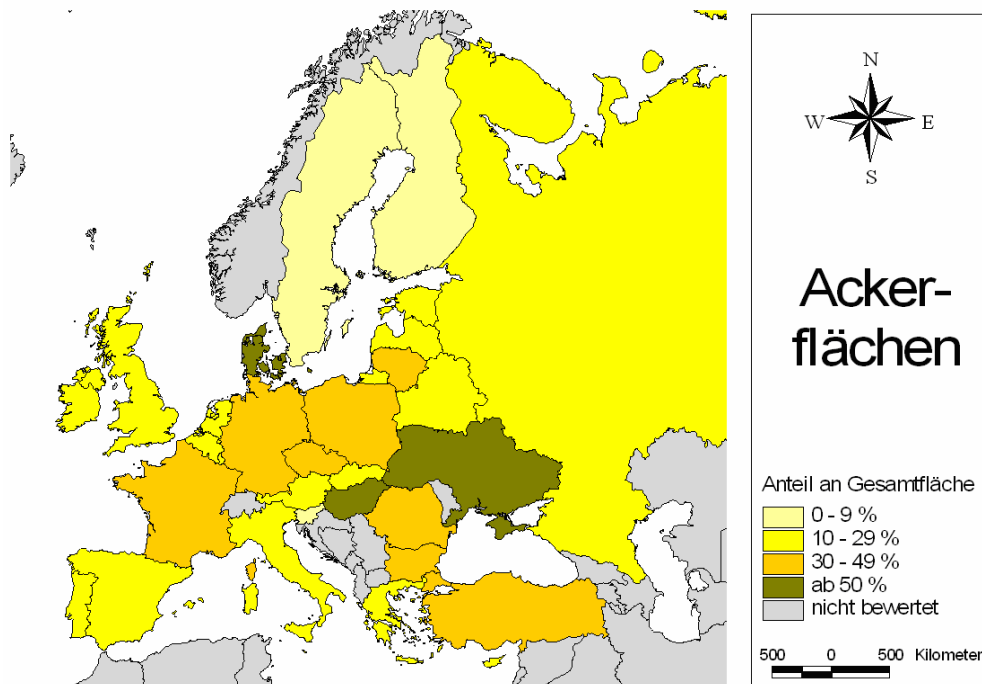

Illustration 3-4: Current arable land in selected countries of Europe/2/

Key: Arable land
Share of total land
Nicht bewertet = not assessed

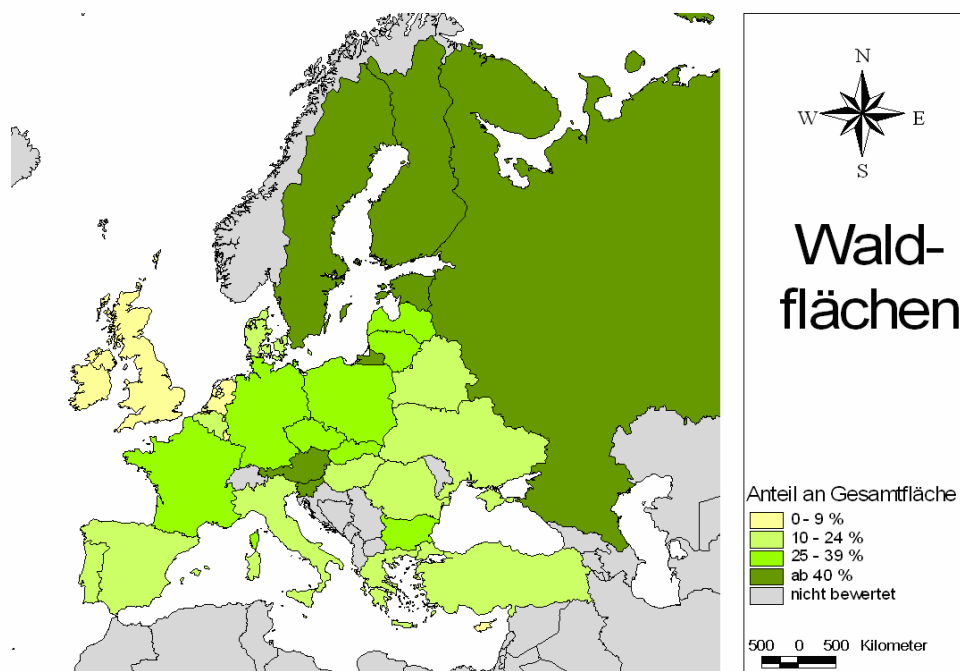

Illustration 3-5: Current forestry land in selected countries of Europe/2/

Key:
Forestry land
Share of total land



3.2.1 Potential for agriculture

Potential agricultural bio energy carriers take various forms. Animal excrement occurring during the farming of livestock and the cultivation of fuel crops are considered below: these might be used for energy purposes under present technical underlying conditions.

In businesses where livestock are managed there is a considerable quantity of animal excrement produced each year, such as manure, solid dung and slurry. When gathering potential in the regions being investigated, records were made of animal excrement produced by keeping cattle, pigs and poultry (hens, ducks, turkeys). For cattle and poultry we assumed that 68% were in sheds and for pigs about 100%.

By fuel crops in the broader sense we mean any crops cultivated for one year or over many years which are used not as food or fodder and are not used for producing the means of production or industrial consumer goods but are used for providing energy /14/. The biomasses produced can be used as biogenous solid fuel, as liquid bio energy carriers or as starting material for biogas production.

The potential is given in PJ/a. For biogas plant this refers to the biogas produced (energy-related details for the substrate used cannot be shown in a meaningful way because of the high water content and the associated low energy density). For bio-SNG plant, this refers to the solid fuel used.

3.2.2 Potential for forestry

The estimate of forestry industry potential is based on the felling statistics of the FAO [UN Food and Agricultural Organisation] and EFSOS [European Forest Sector Outlook Studies] market forecasts on trends in the wood processing industry. A detailed description of procedure can be found in /10/: the details on White Russia, Russia and Ukraine were also found using the same method. Tree felling for use as a raw material in the CIS States is currently comparatively small and will only increase comparatively slowly – there is therefore a lower potential quantity of forestry waste wood to be expected (and industrial waste wood potential). Russia has a considerable proportion of natural forests – these are not assessed as potential in the context of this study.

The basis for determining potential is the annual growth. It is equivalent to the volume of wood per hectare which can be used by felling without weakening the sustainability of the forest. This volume used is equal to the theoretical potential quantity of wood harvested from forests and sold. Various types of wood are the product of tree felling but harvested wood occurs in the greatest proportion followed by firewood and forestry waste wood. The size of current technical harvested wood potential useable for energy purposes can be derived from the following equations:



(1) *Technical harvested wood potential from felling = firewood + forestry waste wood*

(2) *Technical harvested wood potential from growth = theoretical harvested wood potential – felling*

The part of the felling not used as a raw material represents the technical harvested wood potential from felling while the growth per year which was not felled represents the technical harvested wood potential from felling. All volumes given are in t_{atro} or PJ (solid fuel)/a.

3.2.3 Potential for the wood industry

The woods, residues, by-products and waste occurring in the processing and handling of wood are referred to as so-called industrial waste woods. The part of this which can be used for energy generation can also be used as a raw material and competition is fierce. Industrial waste wood comes mainly from the following industries:

- saw mill industry
- wood materials industry
- paper/cellulose industry

The potential in the saw mill industry is predominantly based on saw mill by-products such as shavings, wood chips and off-cuts. Waste wood products come mainly from the wood materials industry and occur during production of boards made from shavings, fibres and/or OSB and they are not recycled as a raw material again, like abrasive dust and bark. The potential within industrial waste wood in the paper and cellulose industry results from the availability of bark. The derived potential can be calculated using the production volume and taking account of a specific waste wood factor. The assumption that 80% can be used to produce energy is applied with regard to the availability of bark.

3.3 Determining biomethane potential

The calculation of biomethane potential from the fuel potential is obtained by using conversion rates of

- 95 % for biogas (starting from the biogas potential)
- 65 % for bio-SNG (starting from the solid fuel potential) .

The gas network density is also taken into account. The access to raw materials shown in Table 3-1 is obtained from the length of the gas network and the defined catchment radii.

Table 3-1: Access to raw materials by biogas and bio- SNG plants along the natural gas pipelines/2/

	Biogas	Bio-SNG
EU15	93 %	97%

EU+10	88 %	96 %
EU+3	50 %	100 %
CIS	53 %	100 %

The results shown are for gas potential from fuel crops irrespective of the generation technology. This will only be identified if a higher potential for bio-SNG is found as a result of transport restrictions for biogas substrates on thin gas networks.

3.3.1 Current potential

The current potential of biogenous gases is shown in Illustration 3-6 f. Fuel crops and forest waste wood are the important raw materials. Significant potential can be found in the EU-15 and in the CIS States. Out of the total potential of 300 billion $\text{m}^3_{\text{N/a}}$ about 117 billion $\text{m}^3_{\text{N/a}}$ can be used for biogas. Bio-SNG has approximately double the fuel crop potential compared to biogas, mainly because of the thinner gas network in the CIS States. Since this technology is not yet market-ready the potential associated with it cannot actually be developed. This includes the range of fuel crops, (only KUP), forestry waste wood and industrial waste wood.

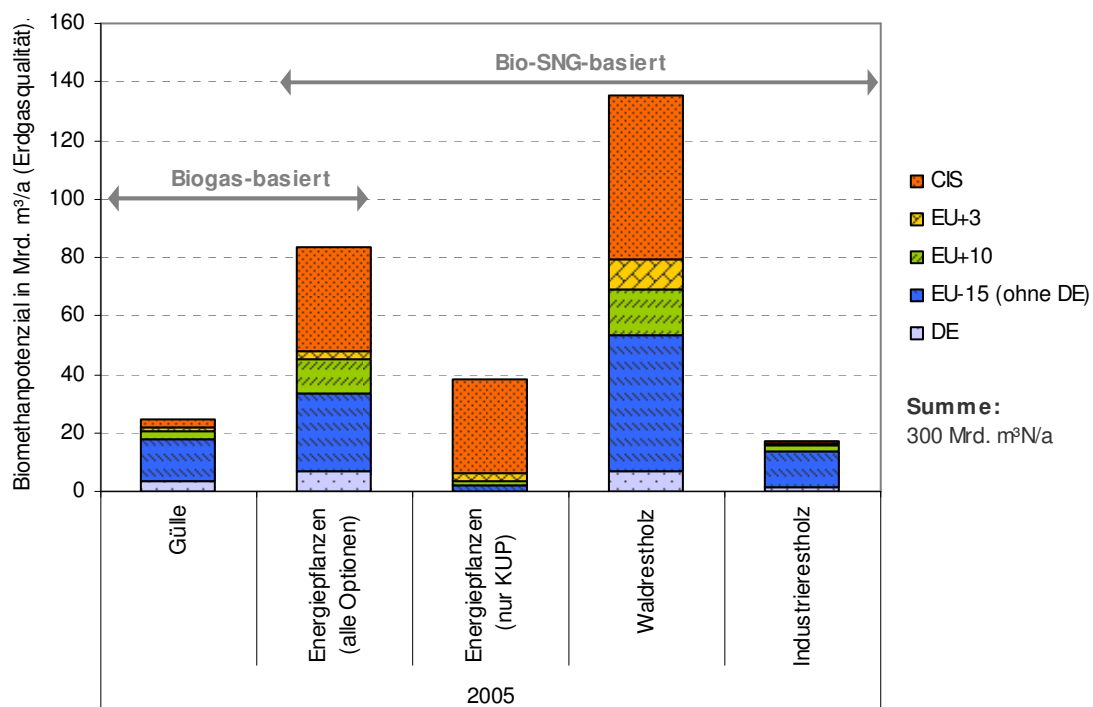

Illustration 3-6: Biomethane potential in 2005 according to raw materials

Key:
Biomethane potential in billion m^3_{a} (natural gas quality) left axis
Bio-SNG based

EU-15 (without DE)

Total:
300 billion $\text{m}^3_{\text{N/a}}$

Manure/fuel crops (all options)/fuel crops (only KUP⁶)/ forestry waste wood/ industrial waste wood

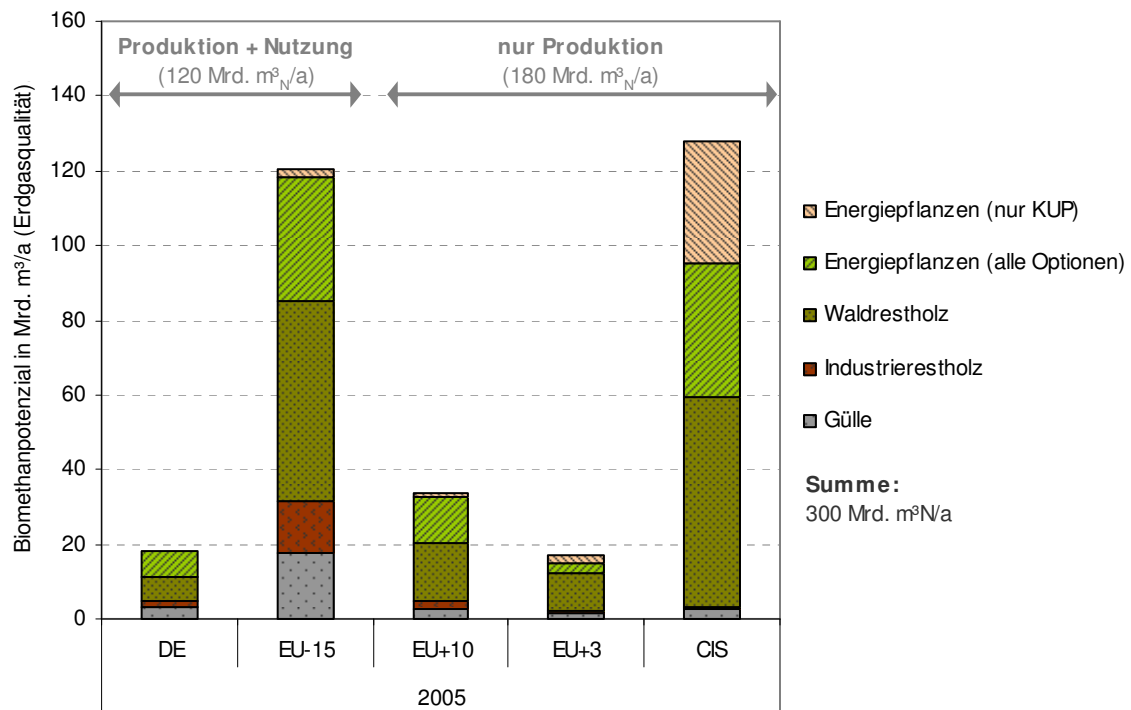

Illustration 3-7: Biomethane potential in 2005 according to regions

Key:

Biomethane potential in billion m³/a (natural gas quality) left axis
 Production + use only production

Fuel crops (only KUP)
 Fuel crops (all options)
 Forestry waste wood
 Industrial waste wood
 Manure

Total:

3.3.2 Future potential

The expected potential for biogenous gases for the year 2020 is shown in Illustration 3-8f. The significance of fuel crops is clearly increasing in all regions, raising the total potential to 485 billion m³N/a. Half of the potential (c. 243 billion m³N/a) could be opened up through biogas in 2020.

⁶ KUP Kurzumtriebsplantagen – fast growing plantations

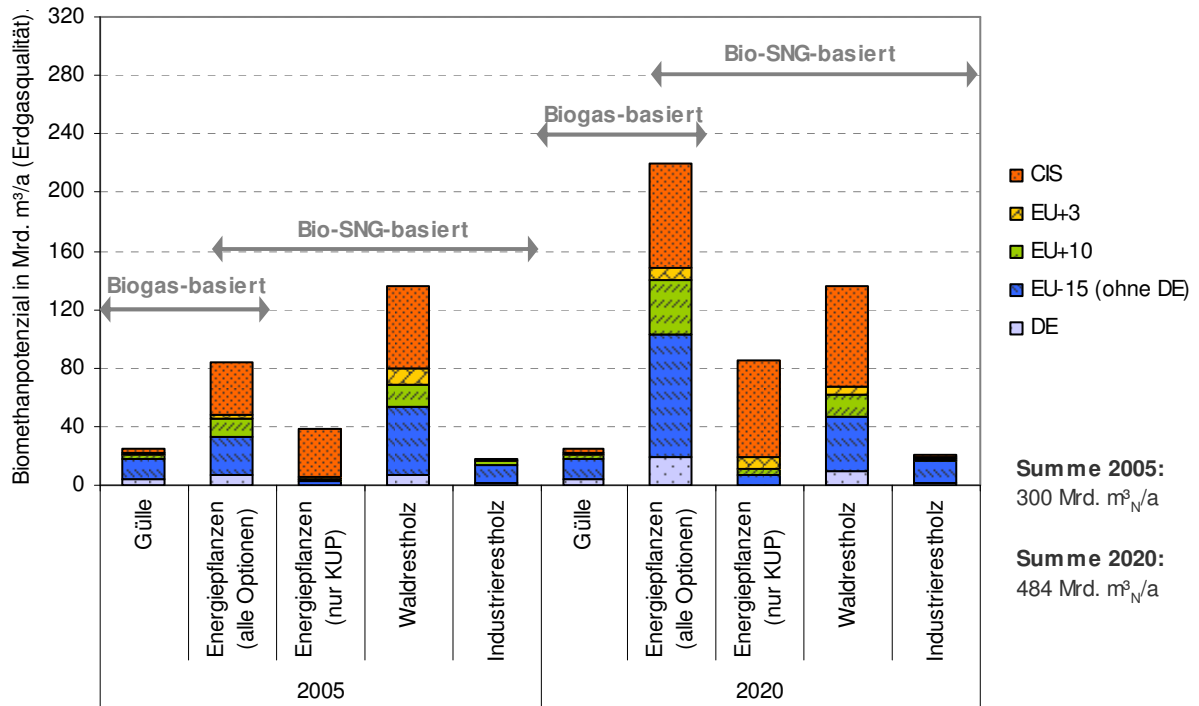

Illustration 3-8: Biomethane potential in 2020 according to raw materials

Key:
 Biomethane potential in billions m³/a (natural gas quality)
 Biogas-based
 EU-15 (without DE)

Total 2005:
 (Right axis left to right)
 2005 Manure/fuel crops (all options)/fuel crops (only KUP)/forestry waste wood/industry waste wood/
 2020 manure/fuel crops (all option)/fuel crops (only KUP)/forestry waste wood/ industrial waste wood

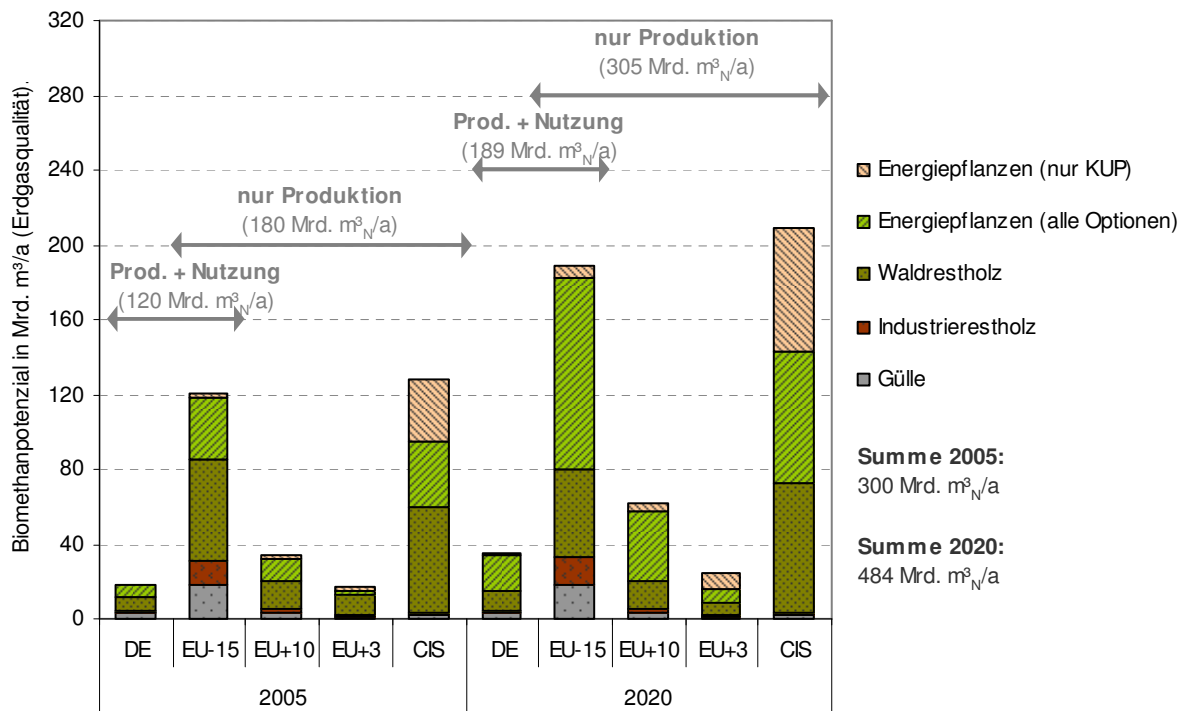

Illustration 3-9: Biomethane potential in 2020 according to raw materials

Key:

Biomethane potential in billions m³/a (natural gas quality)

Only production

Prod + use

Only production

Prod + use

Fuel crops (only KUP)

Fuel crops (all options)

Forestry waste wood

Industrial waste wood

Manure

Total 2005:

Total 2020:

Additional information about the band width of the expected corridors can be obtained by looking at the boundaries again. The boundary assumptions shown in Table 3-2 were used. The results are shown in Illustration 3-10. The band width found indicates a corridor of $\pm 25\%$ around the basic scenario considered, within which potential development might move in future.

Table 3-2: Assumptions about the limiting case considerations of future potential

	Reduced potential	Increased potential
<i>Acreage available for cultivation of fuel crops</i>		
EU-28 ^a	Only 2/3 of the areas becoming free for the cultivation of fuel crops available as a result of more ecological farming etc. ^b	Not varied
CIS	15 % of arable land	25% of arable land
<i>Fuel crop yield</i>		
All regions	Not varied	+ 30 %
<i>Taking account of all residual materials</i>		
All regions	Not varied	Additional 15 % of the potential found for 2005

^a EU = EU-15 – EU+10 + EU+3

^b E+-scenario from /11/

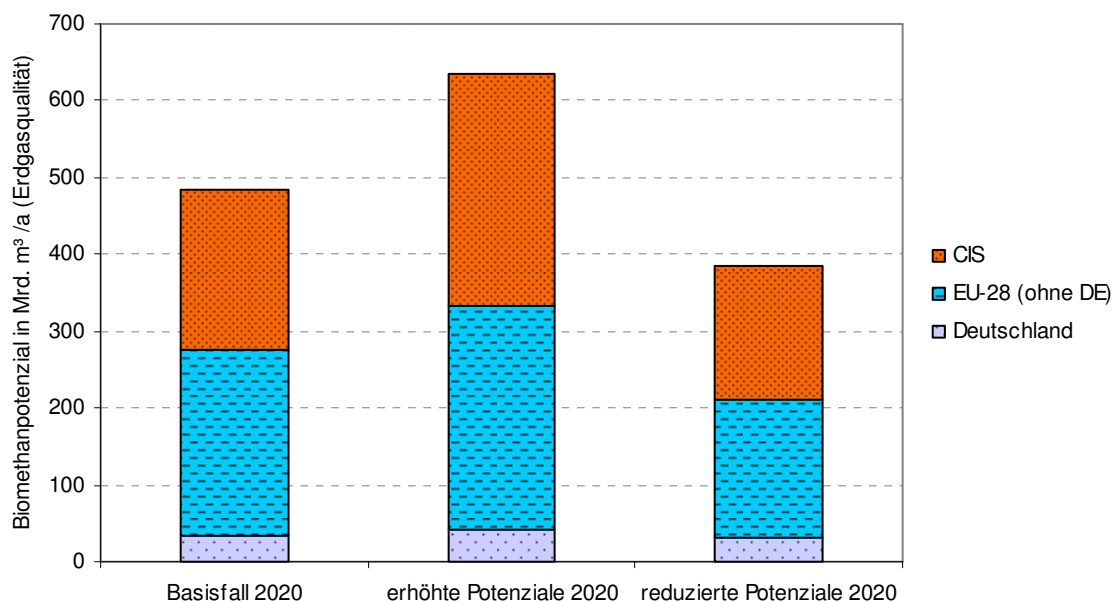

Illustration 3-10: biomethane potential in 2020 – “Sensitivity”

Key:

Biomethane potential in billion m³/a (natural gas quality)

EU-28 (without DE)

Germany

Basic case 2020

increased potential 2020

reduced potential 2020

3.4 Classifying the potential

Below is a classification of the potential. This has been achieved by looking at substitution potential within current and future natural gas consumption in the regions investigated. The demand for equipment needed to develop such potential was also looked into.

3.4.1 Substitution potential

The potential found may replace fossil natural gas. The substitution potential depends essentially on the natural gas consumption of countries. Illustration 3-11 shows biomethane potential compared to natural gas consumption. Based on a purpose-built supply, the total biomethane produced and supplied in Europe in 2020 may extensively replace the current natural gas consumption of the European Union.

There is also considerable demand for natural gas in the CIS States which would then need to continue to be covered by fossil energy sources.

A rise in natural gas consumption is expected. If this does happen, the natural gas consumption of the EU-28 will only be attained in 2020 if potential is favourably developed and completely taken up. The comprehensive taking up of energy-saving and efficiency options is absolutely vital if there is to be a sustained strategy for supplying Europe with biogenous gases: the more successful we are at reducing natural gas consumption permanently the greater the potential for substitution by biomethane will be.

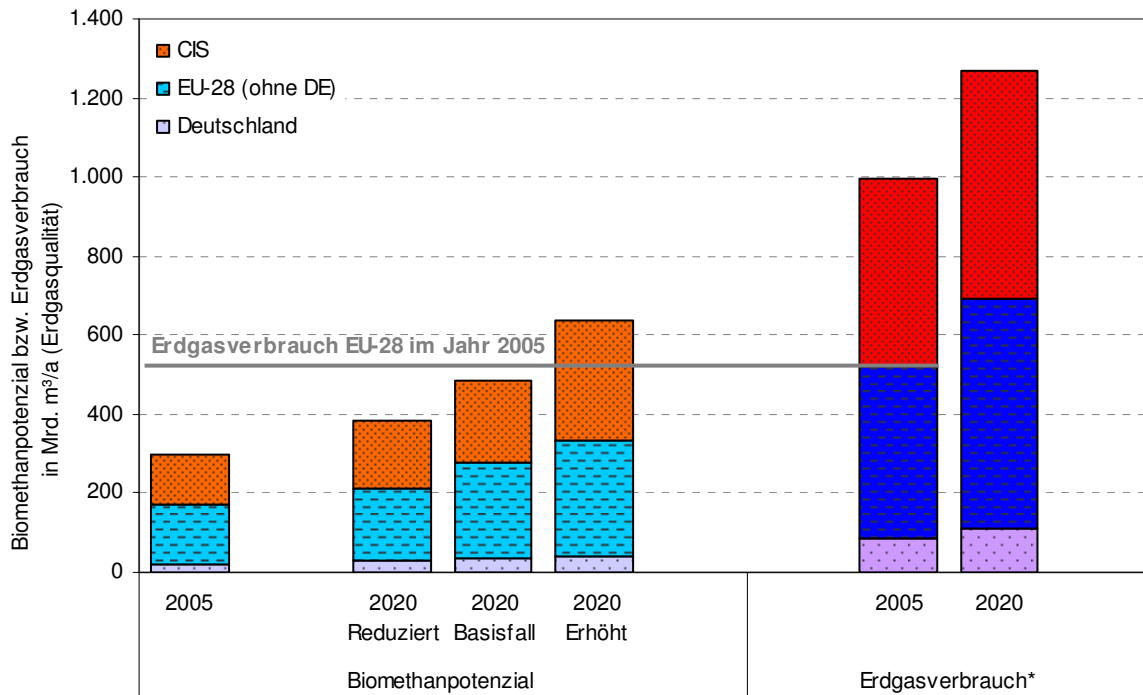

* Abschätzung auf Basis der Prognosen für GUS-Staaten

Illustration 3-11: Biomethane potential and natural gas consumption for 2005 and 2020 /1/, /35/

Key:

Verbrauch = consumption
Ohne DE = without Germany
Potenzial = potential

Natural gas consumption EU-28 in 2005

Biomethane potential or natural gas consumption in billion m³/a (natural gas quality)

Right axis: reduced, basic case, increased

Biomethane potential

* estimated based on forecasts for CIS States

Natural gas consumption

3.4.2 Demand for equipment

Considerable quantities of generation and supply equipment for producing biomethane will have to be provided in order to open up the biomass potential described. At present about 1 million m³ of biomethane per year are produced in a biogas plant and about 133 million m³ biomethane per year in a bio-SNG plant (see Chapter 2.4.2). This corresponds to a computed demand for equipment to supply 485 billion m³ in the year 2020 of 485,000 biogas plants or 3,600 bio-SNG plants. In any case we have to assume that the average number of plants will rise as this type of plant becomes established, so that a figure of 50,000 to 100,000 biogas plants or 2,000 bio SNG plants can be expected. Finally the potential can only be opened up by using a combination of biogas and bio-SNG plants which could be attained, for example, by a combination of 25,000 to 50,000 biogas plants and about 1,000 bio-SNG plants.

The basic differences between biogas and bio-SNG need to be outlined with respect to acquiring plant:



- **Biogas plants** are established and available on the market. For the remaining 13 years up to 2020 a major development of potential can be obtained by building about 2,000 to 4,000 plants on average each year. Such additional building for Europe looks achievable in the coming years.
- **Bio-SNG plants** will only be on the market from 2015 onwards. To develop potential 200 plants will have to be built annually up to 2020; such a target seems very ambitious and first requires research and market penetration strategies both with regard to finding locations and with regard to availability of sufficient providers of the concept and the components.

By 2020, therefore, the possibilities of developing potential with regard to the generation of biogas are clearly more favourable than those for generating bio-SNG.

4 Supply costs

A decisive/crucial aspect in the assessment of a strategy for supplying natural gas substitutes is the costs associated with biomethane production and its supply. The core questions have to do with (i) the typical supply costs to be expected (ii) the important cost differences between EU-15, the accession countries, those awaiting accession and the aforementioned CIS States and (iii) the factors which could cause a further development of costs. Below is an estimate of the supply costs for biogenous gases as a model – based on practice – of the promising application options today. The supply costs are then determined starting with a description of the methodical approach used to calculate costs.

4.1 Methodical approach

The preparation and supply of biogenous gases can be achieved using various technologies. Having decided whether to set up for the medium or long term, broadly similar cost structures can be assumed. Despite the technologies not yet being available on the market (e.g. for bio-SNG) it is already possible to provide typical plant sizes and raw materials. We can assume that the state of the art will be extensively standardised for the EU-28. The costs specific to investment can therefore be estimated using models and the cost calculation model described below. The results are shown using a so-called basic scenario (i.e. for Germany as representative of the member states of the EU-15) in conjunction with a sensitivity analysis with reference to costs of raw materials, personnel and auxiliary energy.

4.2 Cost calculation model

A calculation model based on VDI standards 6025 and 2067 is used to determine the specific production costs of biomethane (Illustration 2-1). The production costs are calculated using the so-called annuity method /31/.

Depending on the relevant bio fuel reference concept, the specific capital costs, raw material costs and operating and auxiliary energy costs – which show the annual expenditure side – are compared against possible annual credits for secondary products (e.g. manure residues as fertilisers) free plant. The energy-specific production costs related to the lower heat value can be derived (i.e.. €/kWh_{CH₄,th}) depending on the annual biomethane production quantity and taking account of annual inflation rates. The biomethane supply costs can be found by taking account of the energy-specific costs used as a basis for biomethane supply and transportation.

To determine the above capital costs or capital-related costs the following parameters were included:

- the investment costs relating to equipment for typical sizes of plant (i.e. related to biomethane capacity),
- the proportion of equity capital depending on investment volume and capital interest and



- the cost of maintaining the plant.

The determining of investment costs in terms of capacity is achieved by scaling, on the basis of known data (e.g. through bids, knowledge of existing equipment) including a regression factor; this is typically in the order of about 0.70 to 0.95 for technical energy plant/1/.

The following aspects are relevant to the above raw material, operating and auxiliary energy costs:

- material and energy flows relating to a specific concept and operation according to defined balance limits free plant,
- the appropriate generator prices (e.g.. €/t_{RS} for bio mass raw materials maize, manure and fast growing willow to be supplied to the plant),
- prices depending on output (zw.g.. €/MWh_{el} for the auxiliary energy to be supplied to the plant),
- the requirements specific to the plant (i.e.. depending on the plant capacity and complexity) and the annual personnel costs associated with this,
- the expenditure specific to the plant on maintenance and insurance which is shown as a percentage of total investment on the plant.

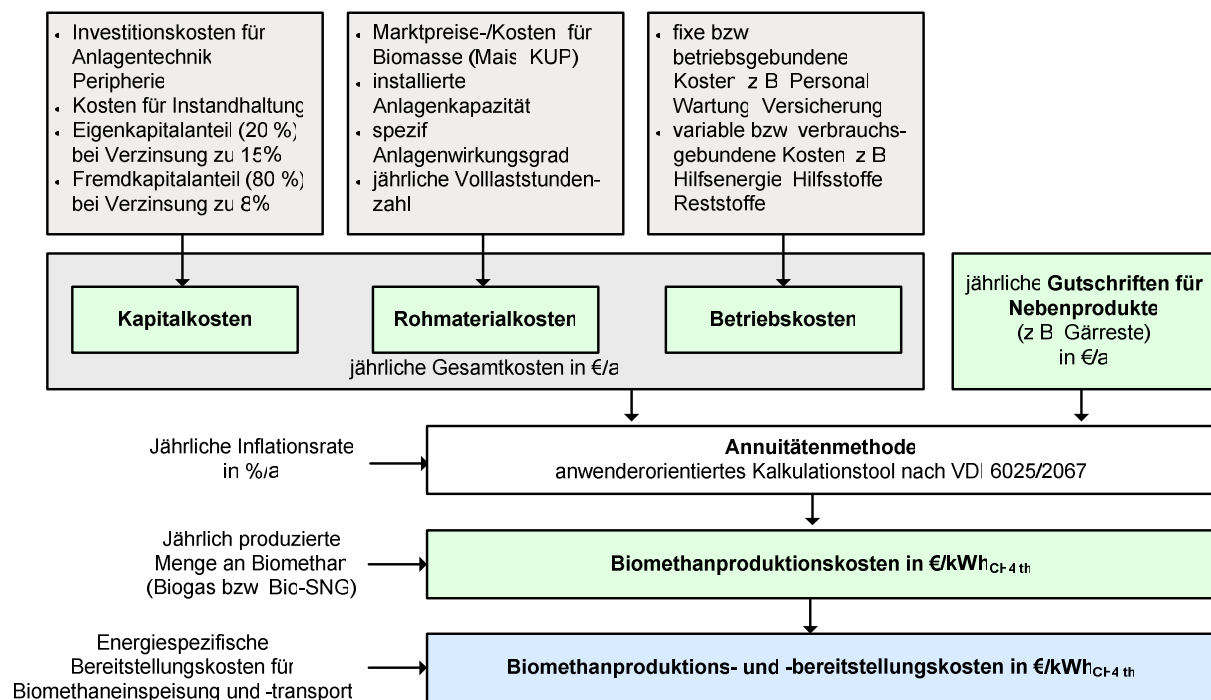

Illustration 4-1: Calculation model for determining the specific biomethane supply costs

Key:

<ul style="list-style-type: none"> • investment costs of equipment • technology periphery • costs of maintenance 	<ul style="list-style-type: none"> * market prices/costs of biomass (maize.,KUP) * installed equipment capacity * specified equipment efficiency 	<ul style="list-style-type: none"> • fixed or operations related costs e.g. personnel, maintenance, 	
---	---	--	--

<ul style="list-style-type: none"> proportion of equity capital (20%) with interest at 15% proportion of external capital (80%) with interest at 8% 	annual number of full capacity hours	<ul style="list-style-type: none"> insurance variable or consumption-related costs : e.g. auxiliary energy, auxiliary materials, waste materials 	
Capital costs	Cost of raw materials	Operating costs	Annual credits for secondary products (e.g. manure waste) in €/a
Annual inflation rate as %/a	Annuity method User orientated calculation tool according to VSI 6025/2067		
Volume of biomethane produced annually (biogas or bio-SNG)	Biomethane production costs in €/kWh _{CH₄,th}		
Energy-specific supply costs for biomethane supply and transportation	Biomethane production and supply costs in €/kWh _{CH₄,th}		

4.3 Broad assumptions and basis of data

The current underlying conditions and assumptions are used as a basis for comparison. We always assume only new build for the plant models considered. The calculated period of consideration is 15 years. The expenditure on commissioning the plant and procedures for starting and stopping the plant, specific taxes and grants of every kind (e.g. from structured promotional funds) are not taken into account.

For both models the following investment costs specific to the plant were used as a basis (i.e. including plant for producing gases rich in methane and their preparation into biomethane at natural gas quality and the appropriate periphery); also 1.5% of the initial investment was calculated as repair costs in both cases (Table 2-1). Considering that the effect of financial parameters (i.e. capital shares and their interest) on biomethane production costs was only marginal, a share of own capital of 20% was applied as standard, with interest of 15% and a proportion of external capital of 80 %, with redemption interest of 8%.

Table 4-1: Investment costs for equipment for procuring biomethane (natural gas quality)

	Biogas	Bio-SNG
Installed plant capacity in kW _{CH₄,th}	1,300	167,000
Important investment components	Biogas plant (wet fermentation of Nawaro manure mix) gas preparation (separator, pressurised water wash and fine desulphurisation)	Gasification reactor (circulating fluidised bed, use of KUP/willow off cuts) gas purification (including tar washes, pressurised water wash, ZnO bed) gas conditioning (e.g. CO water gas shift, fluidised bed reactors) gas preparation (e.g. CO ₂ wash, pressure change adsorption)
Investment costs in 1,000 €	2,037	167,119
Specific investment costs in €/kW _{CH₄, th}	1,565	1,000

A summary of the important cost parameters and costs related to consumption and operation can be found in Table 2-2. Costs associated with operating and insurance, administration and maintenance of the plant were each assumed to be 1% of the relevant investment costs. More operating costs (e.g. wash substances for gas washing, bed material for gasification reactor and catalyst for methanisation) were assumed to be the same in all countries for the sake of simplicity. The same applies to the credit for manure residues used as fertilisers.

Table 4-2: Important cost parameters. Costs related to consumption and operating /32/ ff.

Costs (parameters)	EU-15 (Basic scenario ^a)	EU+10 (EU-accession states)	EU+3 (EU-states awaiting accession)
Average inflation rate as %/a	2.1	3.2	8
<i>Raw material in €/t</i>			
Manure	Cost neutral	Cost neutral	Cost neutral
Maize ^b	21	5 to 42	25 to 34
Willow (KUP)	75	60	60
<i>Electricity (auxiliary energy) in €/MWh_{el}</i>			
	60 to 100	60 to 140 ^c	25 to 110 ^c
Personnel (per employee) in €/a	45,000	4,300 to 23,000	2,600 to 3,300 ^d

^a Germany as example of a representative

^b Producer's/generator's price

^c Eurostat, 2003 ff. And /26/

^d Here: on behalf of Bulgaria and Rumania

The costs of supplying biomethane and transportation over the natural gas long distance network plays a rather secondary role here, even if it was only initially estimated very roughly because the cost and supply situations vary between countries.). About 1.3 €/ct/kWh_{CH₄,th} are assumed for supplying biogenous gases to the natural gas network and transportation over 2500 km for the small output sector (i.e. biogas equipment) and about. 1.1 €/ct/kWh_{CH₄,th}. for the medium to large output sector (i.e. bio-SNG plant).

4.4 Results

The total costs of biomethane, which are made up of the production costs for biomethane and the cost of its supply and transportation over 2500 km, are shown below for biogas and for bio-SNG. The average costs of the basic scenario for member states EU-15 (with Germany as an example of a representative), the accession states EU+10 and those awaiting accession EU+3 and CIS states, are compared starting from the basic details named in Table 2-1 f. (Illustration 4-2).

According to this, using the underlying conditions which can be estimated at present, the production and supply costs for biomethane are in the order of about 8 to 11 €/ct/kWh_{CH₄,th}, whereas the total costs for biogas are at a higher level. The proportion of supply costs (i.e. biomethane supply and transportation) to the overall costs is about 11 to 14%. The biogas production costs themselves are largely dominated, like capital costs, by the prices of raw materials and the prices of auxiliary energy. In addition to this personnel costs, particularly for the EU-15, have a major effect on total production costs: this is relativised, however, for EU+10 and EU+3 and the CIS states. Conversely the total production costs for bio-SNG are



initially affected by the prices of raw materials, followed by capital and operating costs; personnel and auxiliary energy costs are only of secondary importance.

Contrary to expectations, production costs are higher because of the comparatively unfavourable conditions in the EU+3 countries awaiting accession and the CIS states (i.e. high annual inflation, higher auxiliary energy prices, and sometimes higher prices for raw materials) than they are, for example, for the EU-15. The EU+10 accession states might produce biomethane more cheaply, assuming comparatively cheaper prices of raw materials or personnel costs (only relevant to biogas production). In order to procure and supply biomethane at comparatively cheap cost in future, the yields per acre (e.g. for fuel crops such as maize) must be increased in the countries awaiting accession EU +3 and the CIS states in order to obtain competitive raw material costs. Also the costs of producing auxiliary energy (i.e. electricity) must be reduced and the annual rates of inflation reduced – assuming favourable development of the national economy and political underlying conditions.

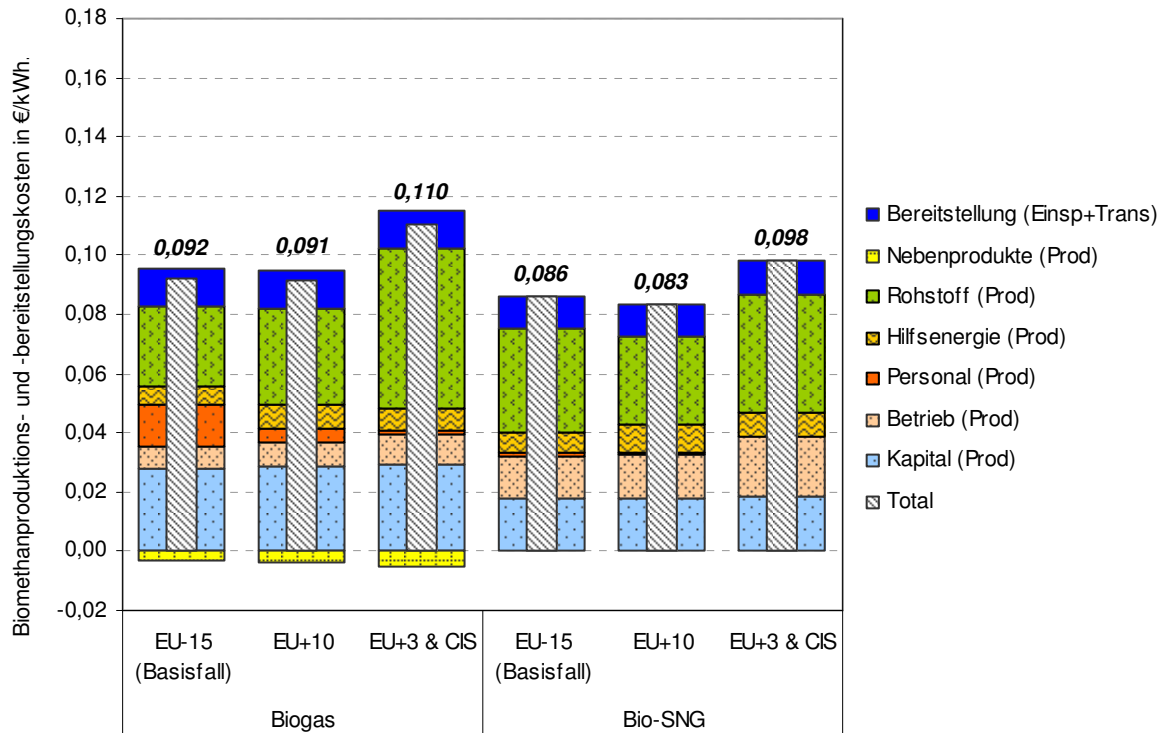

Illustration 4-2: Production and supply costs for biogas and bio-SNG

Key:

Biomethane production and supply costs in €/kWh

□ preparation (supply + transport)

□ by products (prod)

□ raw materials

□ auxiliary energy

□ personnel

□ operating

□ Capital

Basic scenario/biogas/ basic scenario bio-SNG/

Starting with the basic scenario - a comparison was also made, following a sensitivity analysis, using minimum or maximum prices for raw materials and auxiliary energy, inflation, and the best case scenario (i.e. minimum prices and inflation) and the worst case scenario (i.e. maximum prices and inflation) (Illustration 2-3f). The allocation was for all regions based on details from Table 2-2. Clearly it is particularly the prices of raw materials and the annual

inflation rate which have a major influence on total costs, both for biogas and for bio-SNG production.

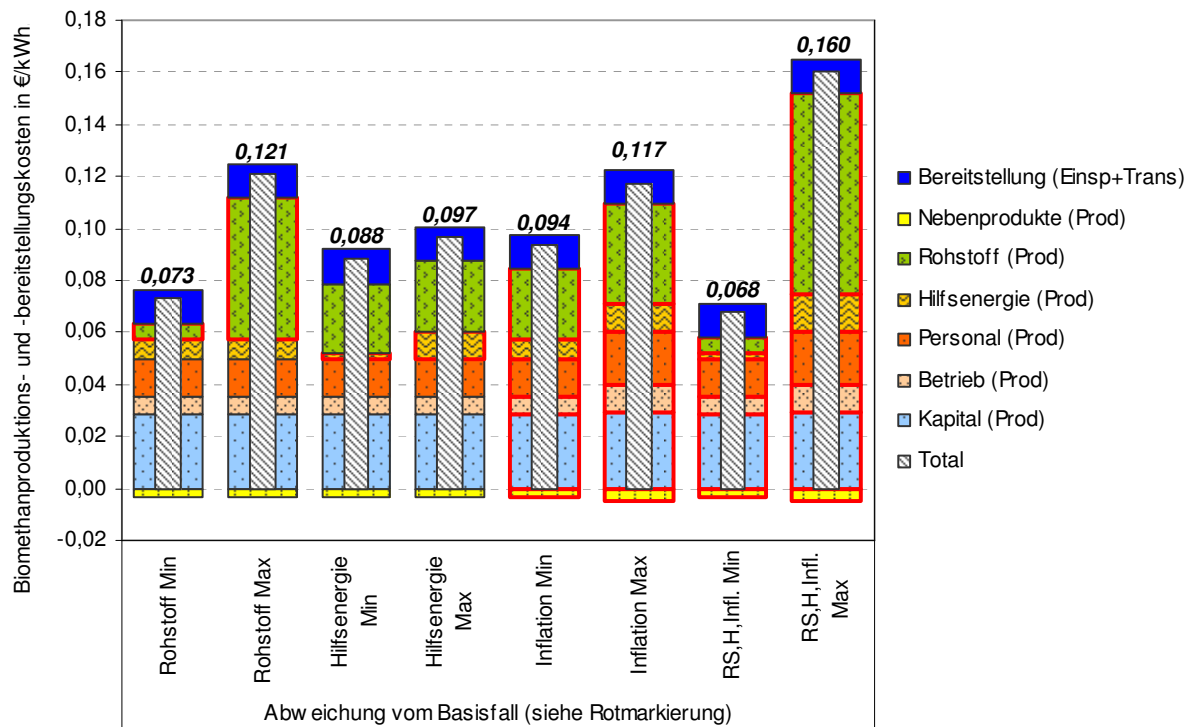

Illustration 4-3: Production and supply costs for biogas (“sensitivity”)

Key:

Biomethane production and supply costs in €/kWh

□ preparation (supply + trans)

□ secondary products (prod)

□ raw materials

□ auxiliary energy

□ personnel

□ operating

□ capital

Raw material min/max auxiliary energy min/max inflation min/max Min (all 3) max (all 3)
Deviation from basic scenario (see red marking)

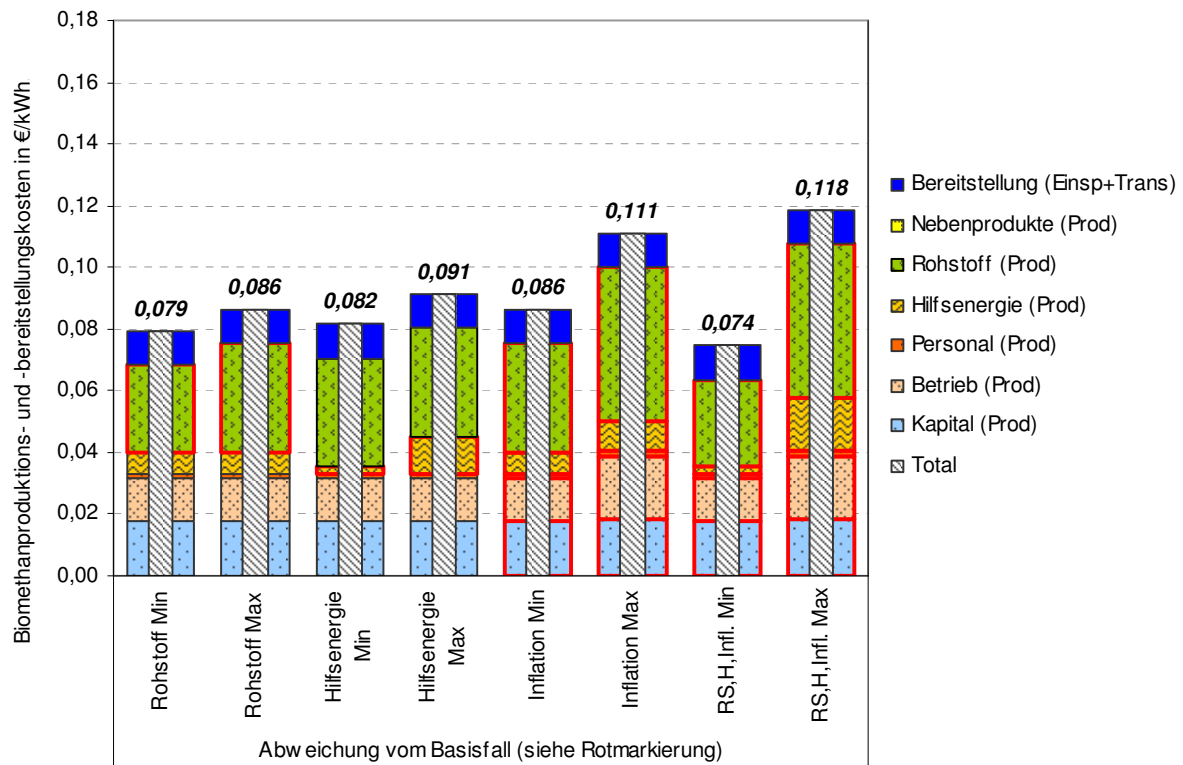

Illustration 4-4: Production and supply costs for Bio-SNG (“Sensitivity”)

Key as above

As is also shown in Illustration 2-5, the expected range of costs is greater for biogas (about 7 - 16 €/kWh_{CH₄,th}) than for bio-SNG (about 7 to 12 €/kWh_{CH₄,th}). Irrespective of this, these costs are significantly above the current prices for natural gas in Europe: given here as a minimum for Latvia (for industrial buyers) and as a maximum for Denmark (for household consumers) /32//33/.

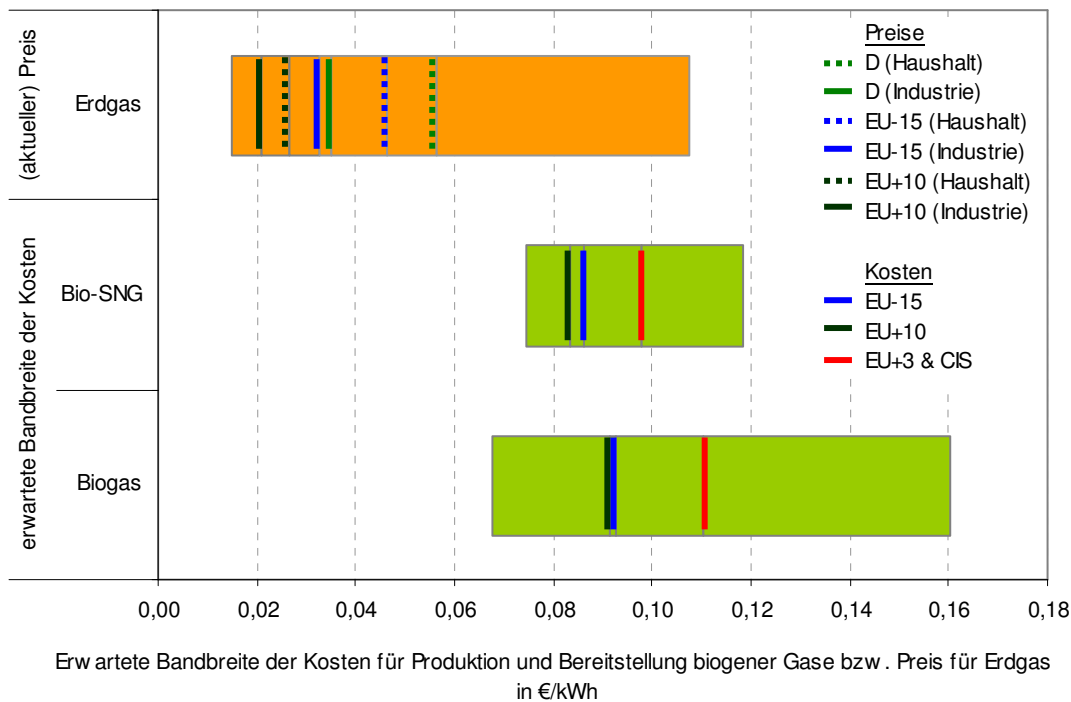

Illustration 4-5: Comparison of expected biomethane costs (all variants, see. Illustration 4-2 ff.) and current price of natural gas (end consumer) in Europe (data from /33/)

Key:

(current) price natural gas	Prices D (household) D(industry)
Expected band width of costs bio-SNG	EU-15 (household) EU-15 (industry) EU+10 (household) EU+10 (industry)
Biogas	Costs EU-15 EU+10 EU+3 & CIS

Expected band width of costs for production and preparation of biogenous gases and/or price of natural gas in €/kWh

The prices of natural gas (including natural gas tax) for Germany are currently ,with a price for crude oil (free border) of about 55 US\$ /barrel, about 3.5 to 5.5 €/kWh_{Erdgas,th} for industrial customers or households (without VAT). If we assume a linear connection between crude oil and gas prices, as has been shown in the past, a price for natural gas of 5.5 to 7.0 €/kWh_{Erdgas,th} (so-called trans-border price) could be expected to accompany a crude oil price free border of 100 US\$/barrel /2/; under very favourable marginal conditions the supply costs for biomethane may be competitive at individual locations. At 150 US\$/barrel, a natural gas price of about 8.0 to 9.5 €/kWh_{Erdgas,th} can be expected /2/; this is equivalent to the currently expected supply costs of biomethane in the European Union. However this does not take into account the fact that rising prices of crude oil might also have considerable effects on prices of biogenous raw materials.



5 Current underlying/basic conditions

The current and future underlying conditions for supplying and producing biogenous gases are of a predominantly economic nature and are also related to energy policy. The essentials include:

- economic production conditions (e.g. wage costs)
- marketing infrastructure (pipelines)
- access to technical opportunities for supplying
- trade restrictions on the domestic market and on export
- possibilities of supplying biogenous gases
- gas prices at home
- subsidies/taxes
- environment (emissions of noise and pollutants, waste disposal)
- by-products (emissions trading, stakeholders)
- political underlying conditions (political risk rating – e.g. government stability, corruption, domestic conflicts).

Selected results are shown in the table below. Details have been summarised in country specifications (Annex B). The analysis of the underlying conditions is carried out together with AP7 in Sub-report 2.



Table 5-1: Summary of the current underlying conditions of selected countries of the EU+10 and EU+3+CIS-States

Country	Legal position	Unbundling	Network access	Gas price in €/GJ		Marketing infrastructure ^a in km	Supply infrastructure ^b in km/km ²
				Household	Industry		
EST	priv/monopoly	Yes	No idea	6.81	4.14	2,000	1.29
LV	privatised	Yes	No idea	6.70	5.39	5,200	0.95
LT	privatised	Yes	High costs	8.14	5.63	1,700	1.18
PL	mostly privatised.	No idea.	High costs	10.21	7.67	107,000	1.20
SK	51% state	Yes	High costs	18.01	7.90	30,500	0.88
SLO	predominantly state./oligopoly	Implemented	Average costs	15.69	5.10	2,500	1.00
CZ	no idea	Implemented	High costs	11.22	8.07	51,000	1.65
HU	mostly privatised	Implemented	Market price	5.21	7.11	65,000	1.73
BG	state./monopoly	Yes	No idea	6.86	4.95	1,700	0.34
RO	privatised	Implemented	No idea	5.71	6.06	3,500	0.86
BEL	state./oligopoly	Not known	No idea	No idea.	No idea.	6,750	0.39
RU	semi-state./monopoly	Not known	No idea	0.95	No idea.	150,000	0.03
UI	state/monopoly	Not known	No idea	No idea	No idea.	37,600	0.28

^a Gas network

^b Length of road network per area of country



6 Summary and conclusions

This sub-report 1 on the study “Possible strategies for European biogas supply” describes the technical possibilities/ways for/of preparing and supplying biomethane for the natural gas network, the current and future biomethane potential and the current and future preparation costs. The period under consideration is from 2005 to 2020. A separate analysis for the old and new member states of the EU, the states awaiting accession (status January 2006) and the European successor states of the Soviet Union (CIS) follows. This division makes sense because the energy and agricultural policy-related underlying conditions of these groups of states are basically different.

The substitution of biomethane for fossil natural gas offers the opportunity to use bio energy in an established field of application with many possible uses. In the medium term there are two efficient technical options available, with biogas and bio-SNG, to produce biomethane to a degree/on a scale worth mentioning. An efficient and comprehensive use of existing raw materials can be attained by using different basic raw materials, different plant sizes (and the associated different potential plant operators) and by combining biogas and bio-SNG plants. The technologies for preparing, compressing and supplying biogas and bio-SNG are also available. However problems can be expected because of restrictions of network access by the energy industry, which have to be reduced on a political level.

To find the available biomass potential a model approach was chosen which was based on (computed) complete food self-sufficiency in the states investigated. Only the arable land available after this can be used for fuel crop production. When considering potential this land was entirely applied to producing biomethane substrates: a yield level was assumed which could be obtained using various fuel crops within different cultivation systems and climate zones. The methane yield of biogas and bio-SNG per acre is of a comparable size (about $3.750 \text{ m}^3_{\text{N}}/(\text{ha}\cdot\text{a})$). In addition to this, the potential for manure, forest waste wood and natural waste wood were recorded. Also the access possibilities to natural gas networks were considered within a certain radius, within which more than 95% of European land masses are included.

The potential found rose from about 300 billion $\text{m}^3_{\text{N}}/\text{a}$ in 2005 to about 500 billion $\text{m}^3_{\text{N}}/\text{a}$ in 2020. The increasing availability of land for agriculture is decisive for potential growth because the acreage needed for production of food is expected to fall. The greatest potential is foreseen in the EU-15 and the CIS states. About half of the potential can be developed using biogas. With full potential development by the year 2020 a figure of 25,000 to 50,000 biogas plants and about 1000 bio SNG plants can be expected.

The potential found could possibly replace fossil natural gas to the tune of about 500 billion m^3_{n} which is equivalent to the current natural gas consumption of EU-28. The future substitution potential is essentially dependent on the consumption of natural gas by these countries. Therefore a comprehensive take up of energy-saving and efficiency options is vital for a sustained strategy to supply Europe with biomethane: the more successful we are in



reducing natural gas consumption permanently the greater is the substitution potential using biomethane. Certainly the potential found represents a maximum figure. In practice there are restrictions through competing energy product use options. In Europe we are mainly talking about wood production for the heating sector, rape cultivation for bio-diesel production and grain cultivation for ethanol production.

The consideration of the costs of preparing biomethane was based on defined model plants. In practice – depending on the underlying conditions - the costs may deviate considerably for each individual case. The calculated generation and supply costs are around 7 to 16 €/kWh_{CH₄,th}. There are no significant cost advantages for Eastern Europe (particularly the CIS states and states awaiting accession). Also the preparation costs of biomethane from biogas and bio-SNG are of a similar order and could, with a crude oil price free border of 150 US\$ /barrel, lie within the range of forecast natural gas prices. Here we have not taken into consideration the fact that rising crude oil prices may also have effects on the prices of biogenous raw materials.

If we are entering upon a biogas supply strategy the development of 10% of the potential found in the medium term seems a conceivable first step. This would mean building about 7,000 biogas plants or 200 bio-SNG plants. This could be achieved easily for biogas but there still needs to be considerable research for bio-SNG. To this extent biogas may assume the function of a bridging technology.

Literature and list of references

- /1/ European Commission: European Energy and Transport Trends to 2030 – Update 2005. Directorate General for Energy and Transport, Office for Official Publications of the European Communities, ISBN 92-79-02305-5, Luxembourg, 2006
- /2/ Institut für Energetik und Umwelt gGmbH: Datenbasis, eigene Berechnungen respektive Darstellungen, Leipzig, 2006/2007
- /3/ Inogate: Interstate Oil and Gas Transport to Europe. Karte, URL: http://www.inogate.org/en/resources/map_gas (Zugriff: November, 2006)
- /4/ Cerbe G.: Grundlagen der Gastechnik – Gasbeschaffung, Gasverteilung, Gasverwendung. Carl Hanser Verlag, München, Wien, 2004
- /5/ Hofmann, F.; Plättner, A.; Lulies, S.; Scholwin, F.; Klinski, S.; Diesel, K.; Urban, W.; Burmeister, F.; Evaluierung der Möglichkeiten zur Einspeisung von Biogas in das Erdgasnetz; Fachagentur Nachwachsende Rohstoffe e.V.; Leipzig 2006
- /6/ VNG-Gespräch; Winkler, L., Fermin, Ch. (VNG); Hennes, J. (Ontras); persönliche Mitteilung
- /7/ Diesel K.(DBI-GUT); persönliche Mitteilung
- /8/ Kühner O.(Greenfield); e-Mail
- /9/ Kaltschmitt, M.; Wiese, A.; Streicher, W. (Hrsg.): Erneuerbare Energien – Systemtechnik, Wirtschaftlichkeit, Umweltaspekte; Springer, Berlin, Heidelberg, 2003, 3. Auflage
- /10/ Fachagentur für nachwachsende Rohstoffe: Handreichung Biogasgewinnung und –nutzung, Gülzow, 2006
- /11/ Institut für Energetik und Umwelt gGmbH: Evaluierung der Möglichkeiten zur Einspeisung von Biogas in das Erdgasnetz, Forschungsvorhaben im Auftrag der Fachagentur für nachwachsende Rohstoffe, Leipzig, 2005
- /12/ Institut für Verfahrenstechnik – TU Wien: Energiezentrale zur Umwandlung von biogenen Roh- und Reststoffen einer Region in Wärme, Strom, BIO-SNG und flüssige Kraftstoffe, Wien, 2005
- /13/ Institut für Energetik und Umwelt gGmbH: Nachhaltige Biomassenutzungsstrategien im europäischen Kontext – Analyse im Spannungsfeld nationaler Vorgaben und der Konkurrenz zwischen festen, flüssigen und gasförmigen Bioenergieträgern, Leipzig, 2005
- /14/ Institut für Agrarentwicklung in Mittel- und Osteuropa: H. Hockmann; persönliche Mitteilung
- /15/ Smeets, E.; Faaij, A.; Lewandowski, I: A quickscan of global bio-energy potentials to 2050, Utrecht, March 2004
- /16/ Verbundvorhaben AGROWOOD: <http://www.agrowood.de/plantagen.php> (Zugriff: November 2006)

- /17/ Diepenbrock, W.; Fischbeck, G.; Heyland, K.-U.; Knauer, N.: Spezieller Pflanzenbau, Eugen Ulmer, Stuttgart, 1999, 3. Auflage
- /18/ Fachagentur für nachwachsende Rohstoffe: Biogasgewinnung und -nutzung, gefördert durch Mittel des BLE, Leipzig, 2004
- /19/ Vetter, A.; Hering, T.; Peisker, D.: Gesetzliche Rahmenbedingungen und Entwicklungspotenzial der energetischen Nutzung von Getreide und Stroh, Seminarveranstaltung „Alternative Brennstoffe“, Berlin, 2006
- /20/ http://www.zoll.de/b0_zoll_und_steuern/c0_marktordnung/b0_einfuhr_mo_waren/a0_getreide/index.html (Zugriff: September 2006)
- /21/ <http://www.destatis.de/basis/d/forst/forsttab5.php> (Zugriff: September 2006)
- /22/ <http://www.fnr.de> (Zugriff: September 2006)
- /23/ Prylutski, A.; Kosenok, I.: Entwicklung des Agrarsektors und der Agrarpolitik in Weißrussland seit 1990, Christian-Albrechts-Universität, Kiel, 2003
- /24/ http://www.fas.usda.gov/remote/soviet/crop_area_2004/russia/rs_millet.htm (Zugriff: September 2006)
- /25/ Fachagentur für nachwachsende Rohstoffe: Schriftenreihe „Nachwachsende Rohstoffe“ Band 24, Biomasse-Vergasung – Der Königsweg für eine effiziente Strom- und Kraftstoffbereitstellung?, Leipzig, 2003
- /26/ Holthausen, N. et al.: Potenziale osteuropäischer Länder für die Produktion von Synthetischem Gas (SNG) aus Holz, Birmensdorf, 2006
- /27/ Wandel, J.: Russlands Agrarpolitik unter Putin, Lucius&Lucius, Stuttgart, 2005
- /28/ Von Cramon-Taubadel, S.; Striwe, L.: Die Transformation der Landwirtschaft in der Ukraine, Wissenschaftsverlag Vauk Kiel KG, 1999
- /29/ Union zur Förderung von Oel- und Proteinpflanzen e. V.: Rohstoffpotenziale für die Produktion von Biodiesel – eine Bestandaufnahme. UFOP, Berlin, September 2006
- /30/ Hamelinck, C.N. & Faaij, A., P.C.: Future prospects for production of methanol and hydrogen from biomass. Journal of Power Sources 111 (2002) 1-22, Department of Science, Technology and Society, Utrecht University, The Netherlands, 2002
- /31/ Verein Deutscher Ingenieure: Betriebswirtschaftliche Berechnungen für Investitionsgüter und Anlagen (VDI 6025). VDI-Gesellschaft Technische Gebäudeausrüstung, Verein Deutscher Ingenieure, Düsseldorf, 1996
- /32/ Eurostat:
http://epp.eurostat.ec.europa.eu/portal/page?_pageid=0,1136206,0_45570467&_dad=portal&_schema=PORTAL (Zugriff: Dezember 2006)
- /33/ Eurostat:
http://epp.eurostat.ec.europa.eu/portal/page?_pageid=0,1136239,0_45571447&_dad=portal&_schema=PORTAL (Zugriff: Dezember 2006)
- /34/ Eurostat:
http://epp.eurostat.ec.europa.eu/portal/page?_pageid=0,1136184,0_45572595&_dad=portal&_schema=PORTAL (Zugriff: Dezember 2006)

- /35/ BP: Quantifying energy BP Statistical Review of World Energy 2006 – Natural gas. June, 2006
- /36/ Seeliger, A.: Entwicklung des weltweiten Erdgasangebots bis 2030. Schriften des energiewirtschaftlichen Instituts, Band 61, Oldenburg Industrieverlag, München, 2006